

Blue Brixx

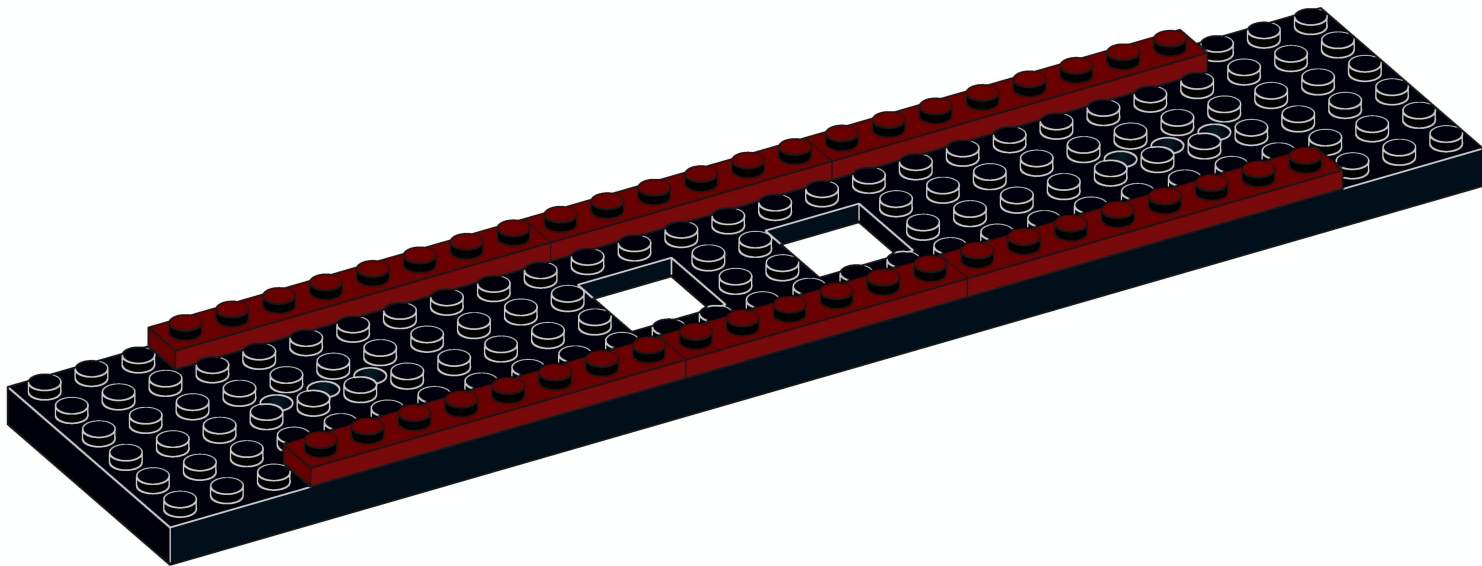

1

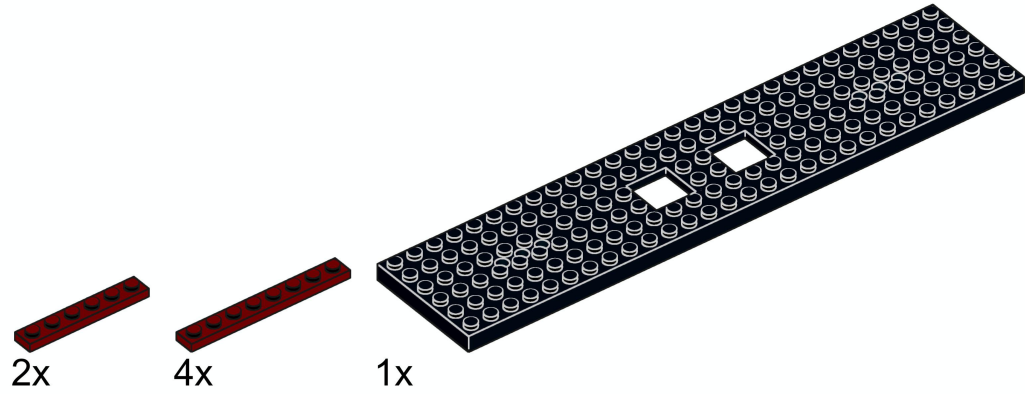

2

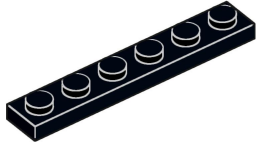

2x

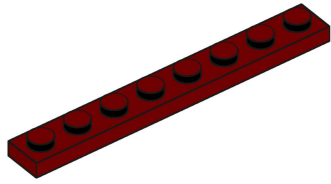

4x



2x

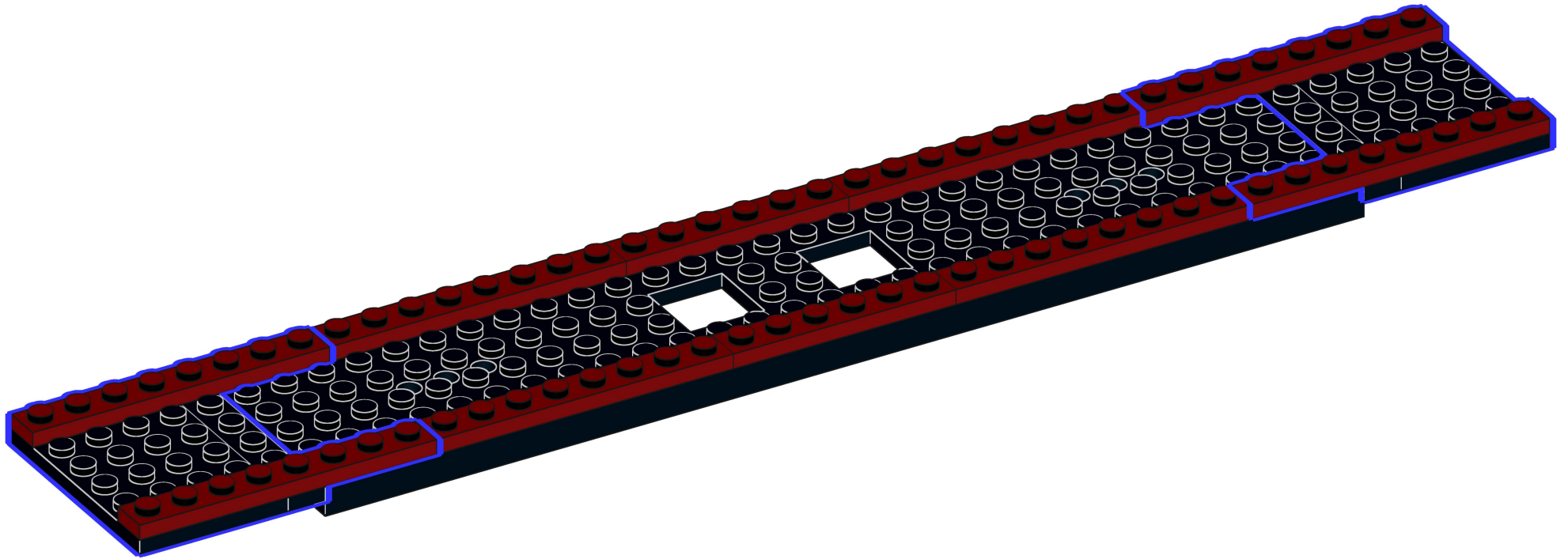

3

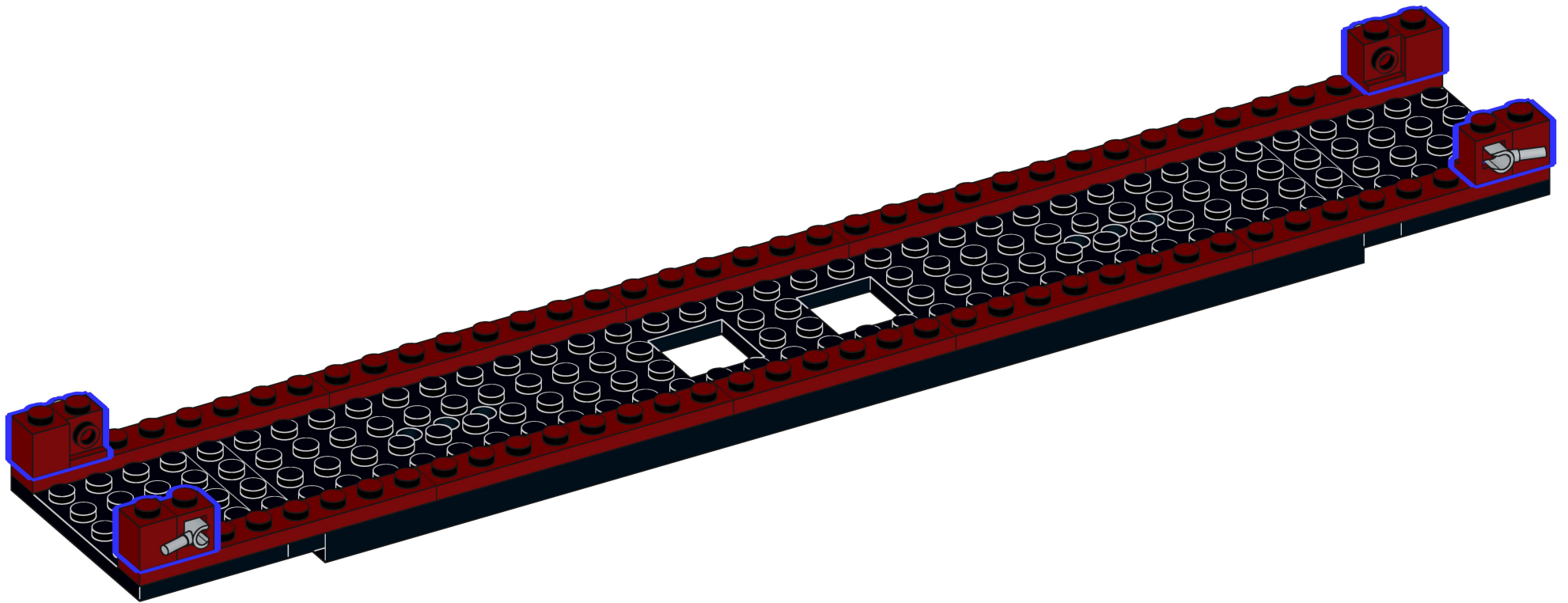
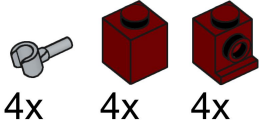

4

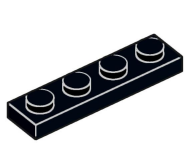

2x

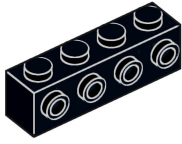

2x

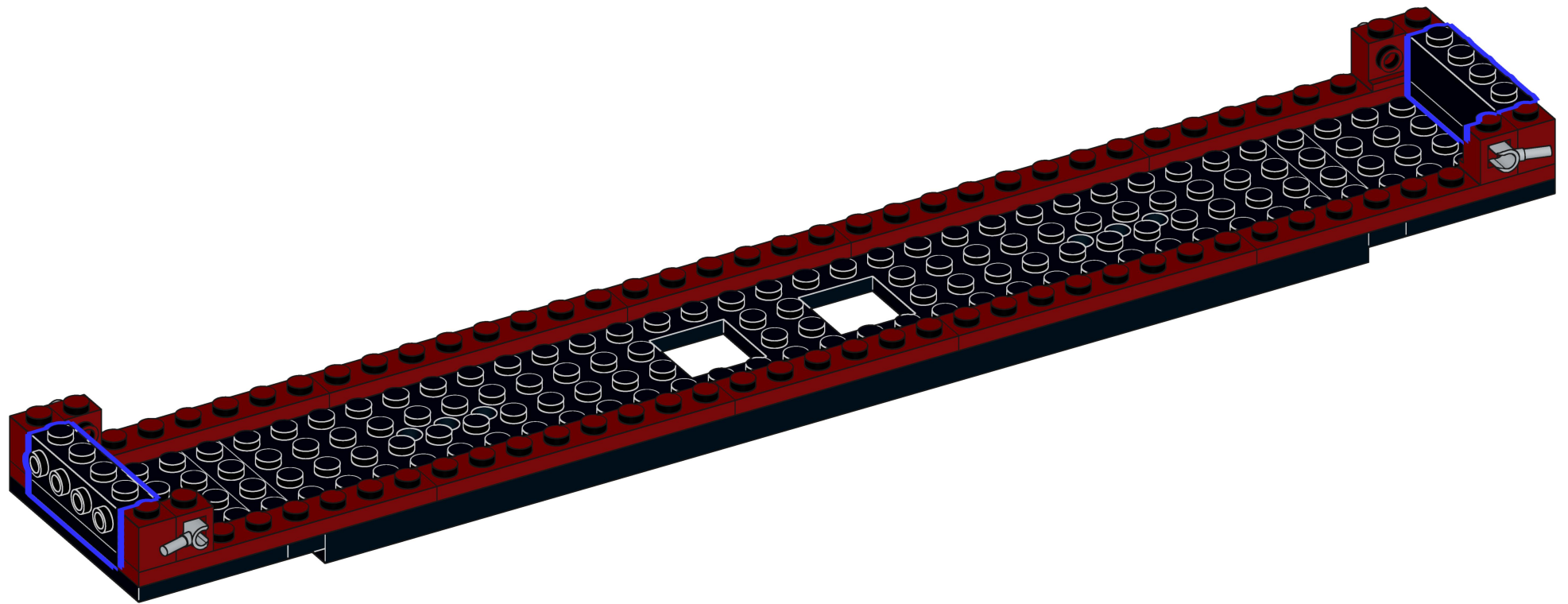

5

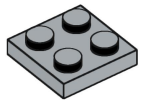

7x

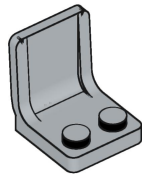

7x

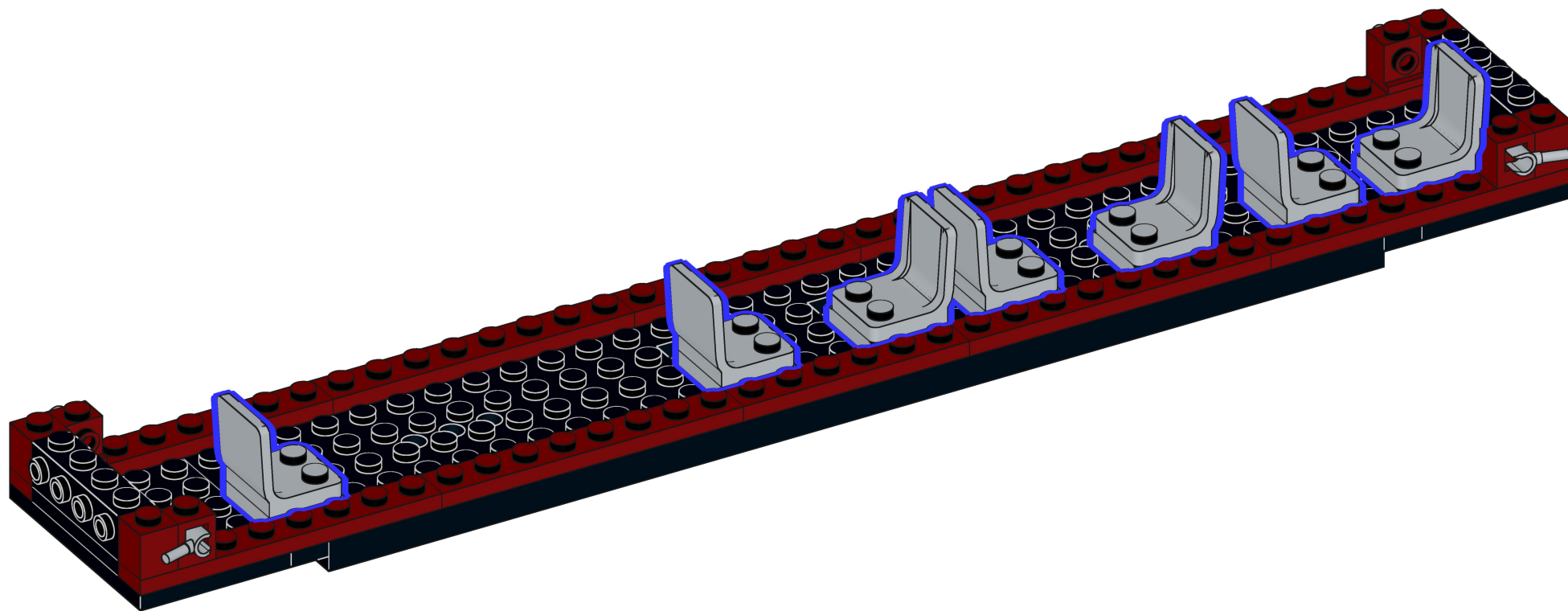

6

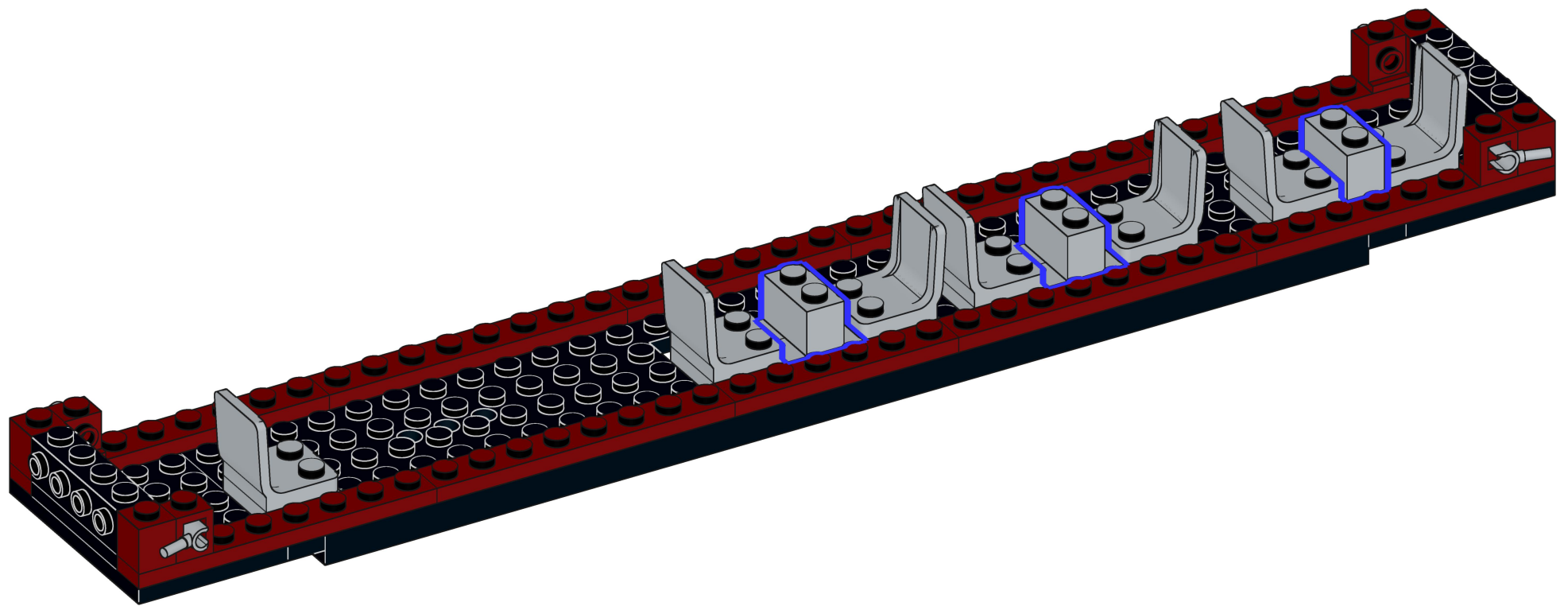
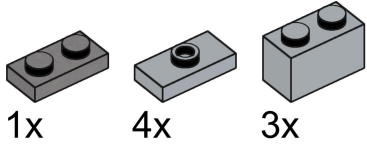

7

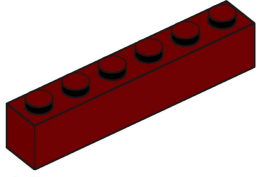

10x

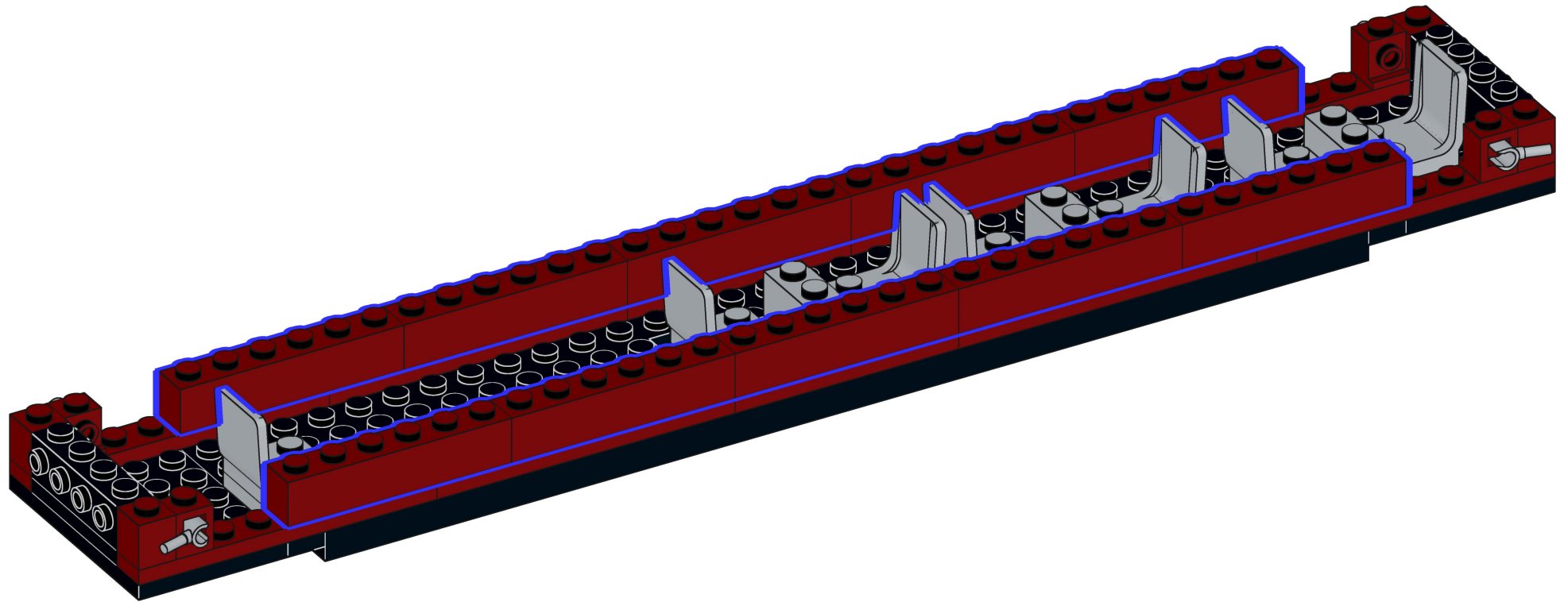

8

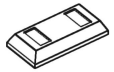

4x



8x

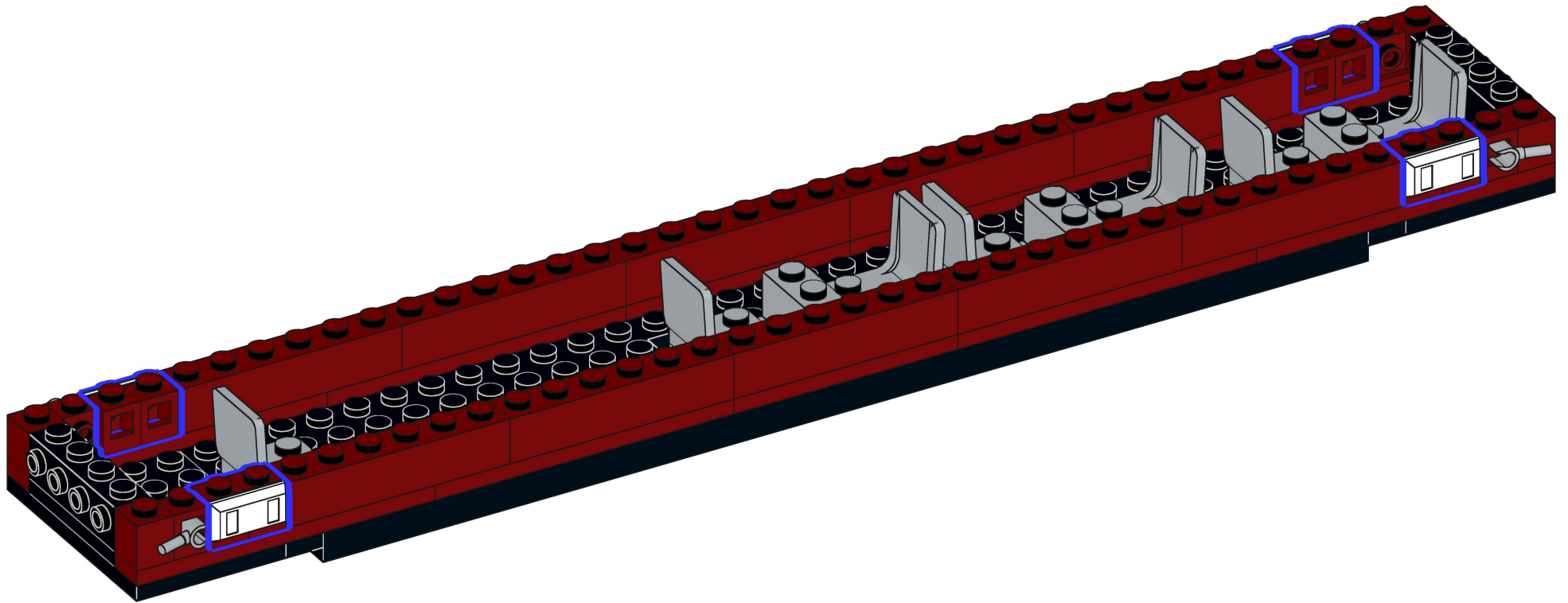

9

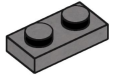

3x



3x

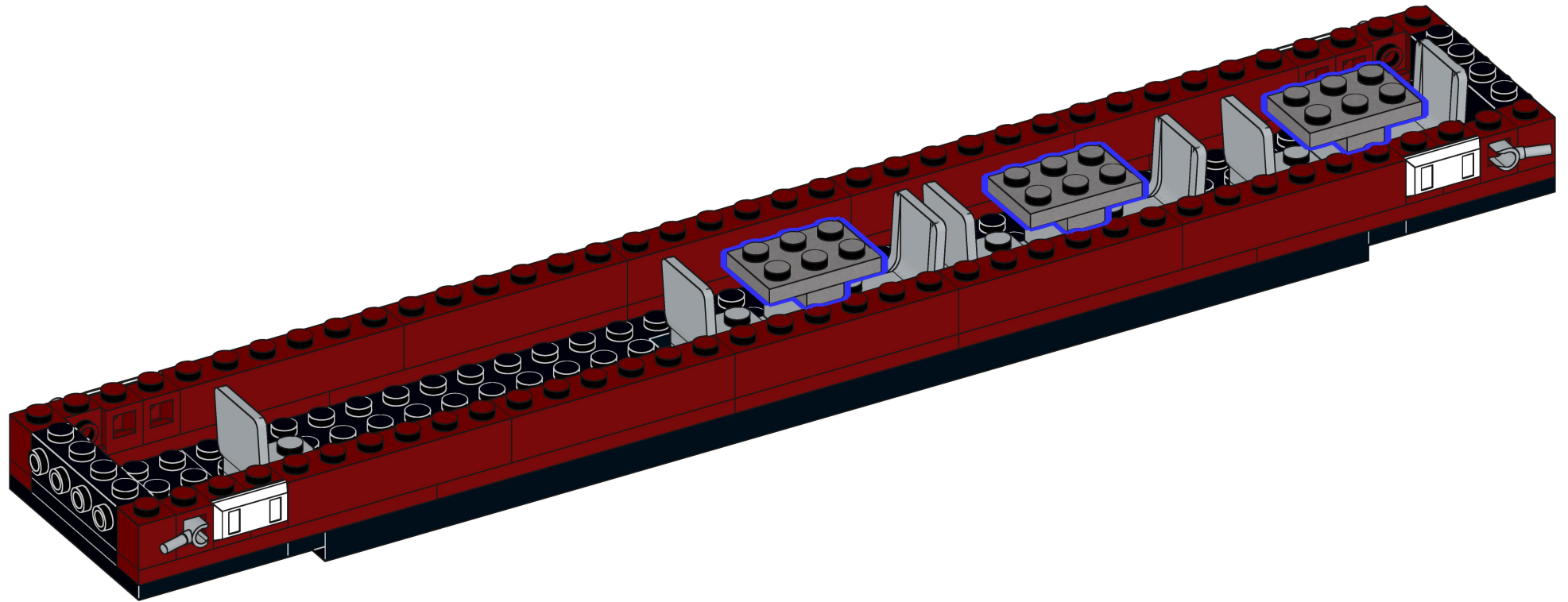

10

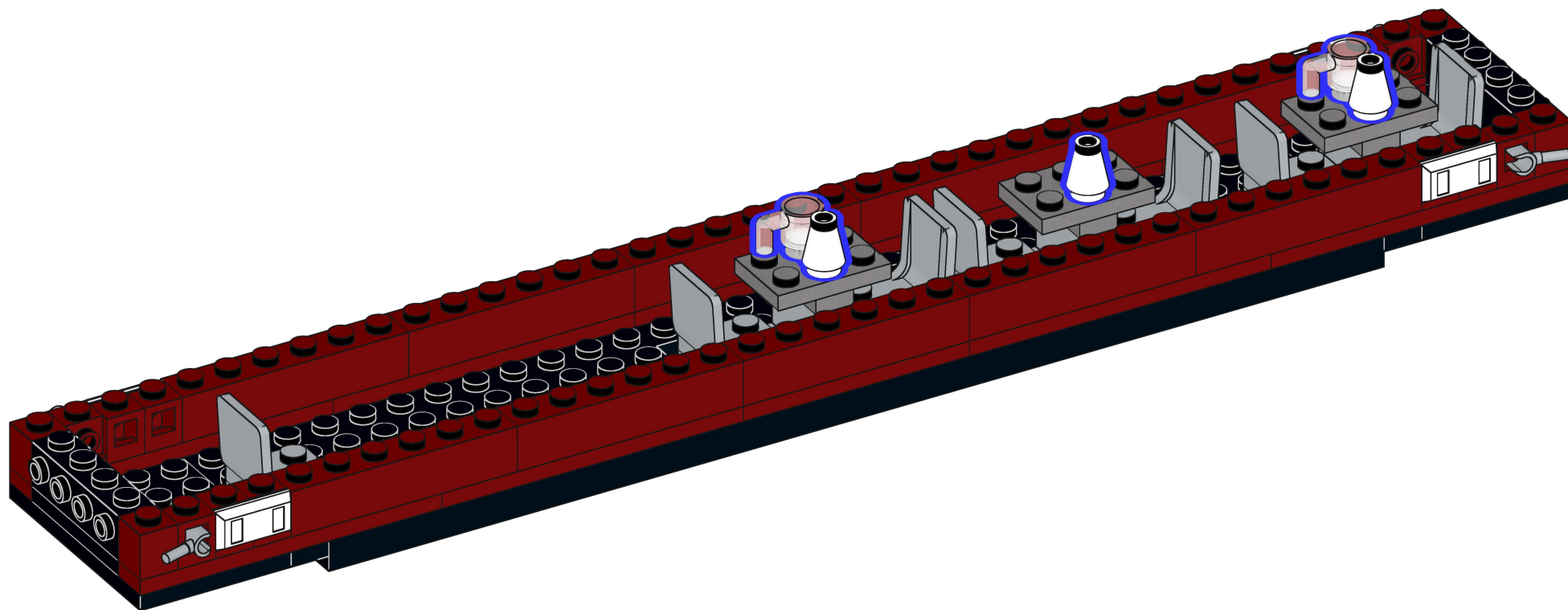
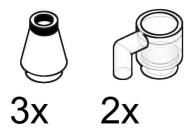

11

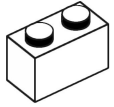

4x

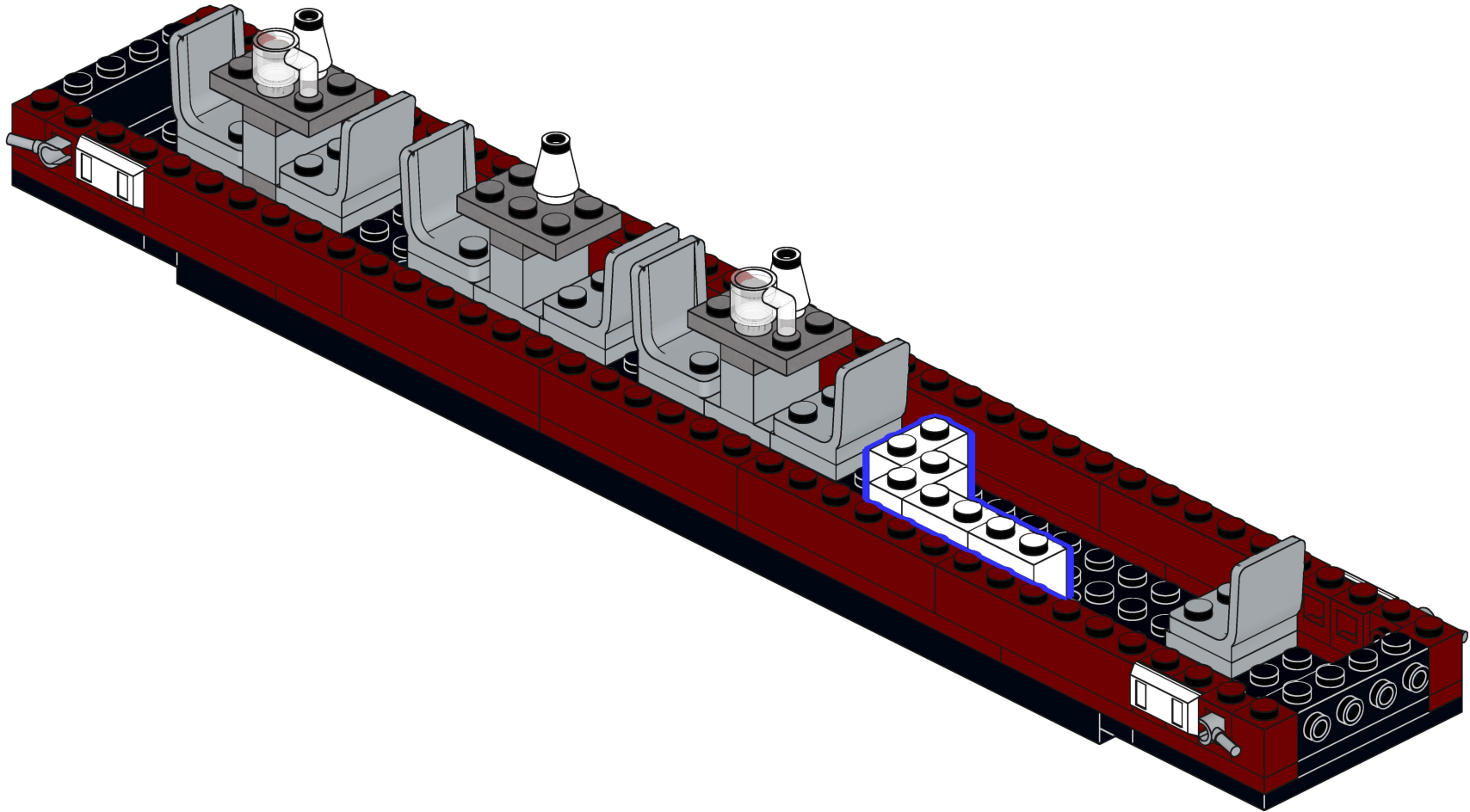

12

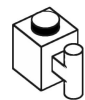

2x

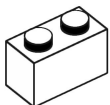

3x

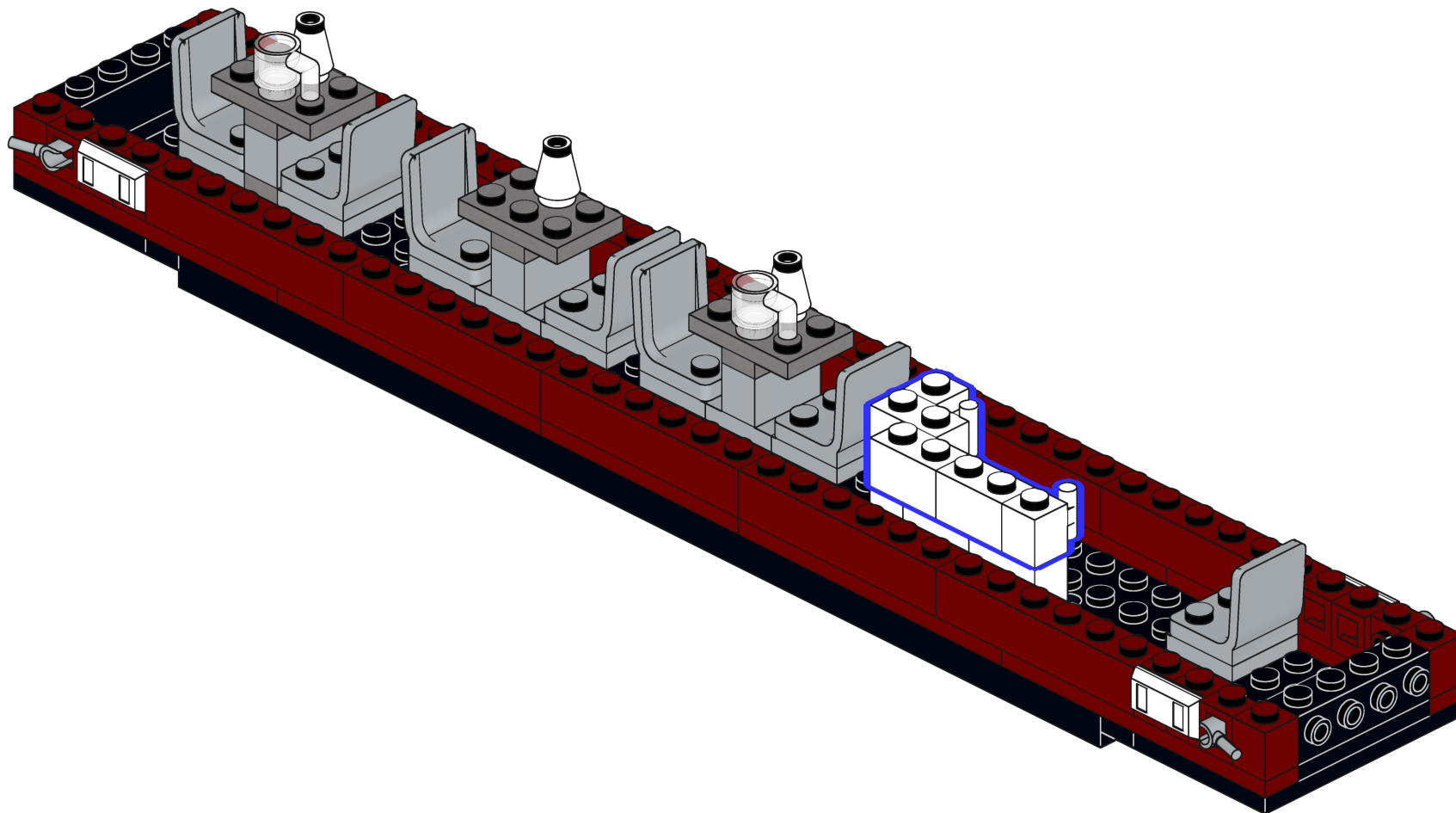

13

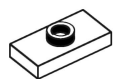

2x



1x



1x

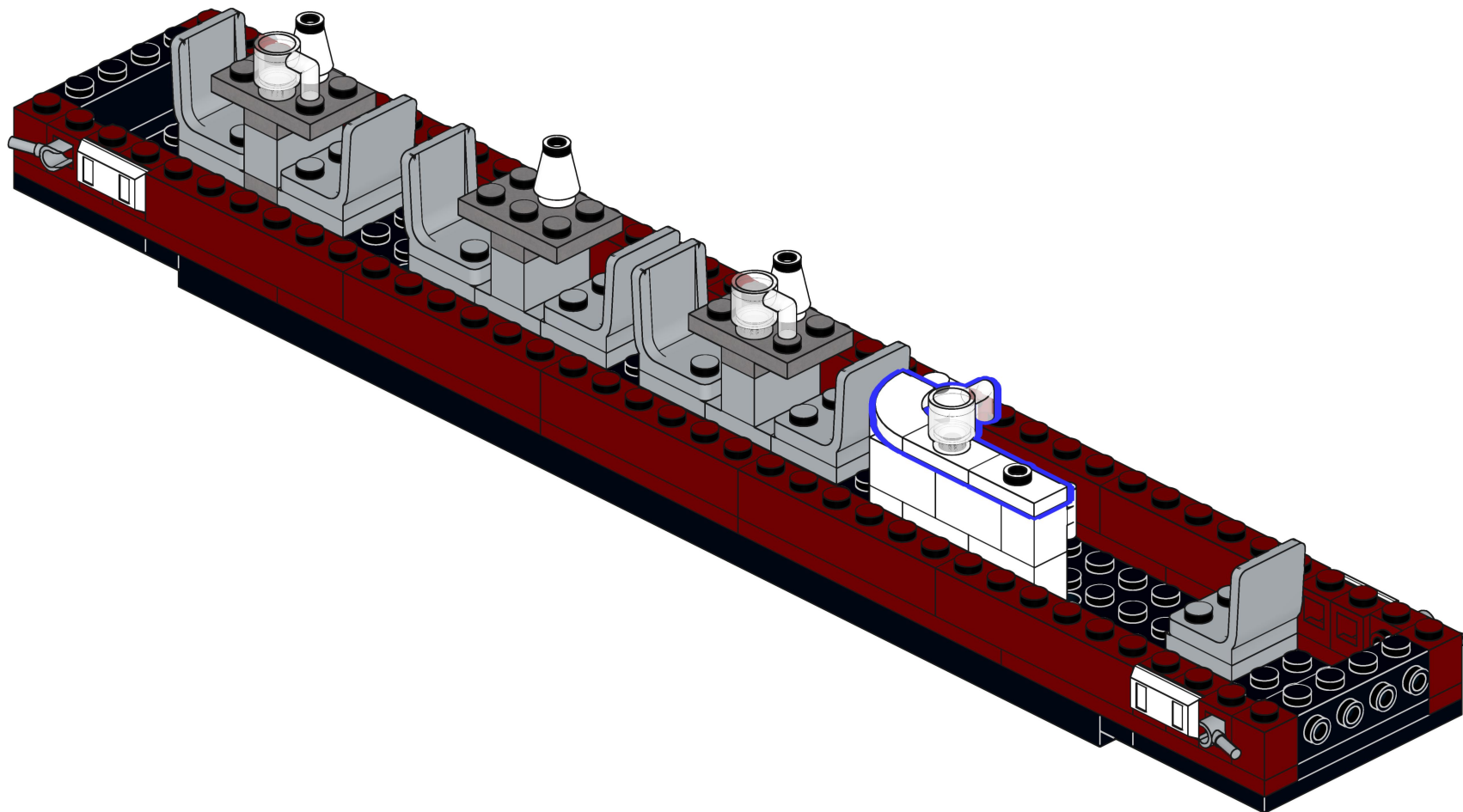

14



1x



2x

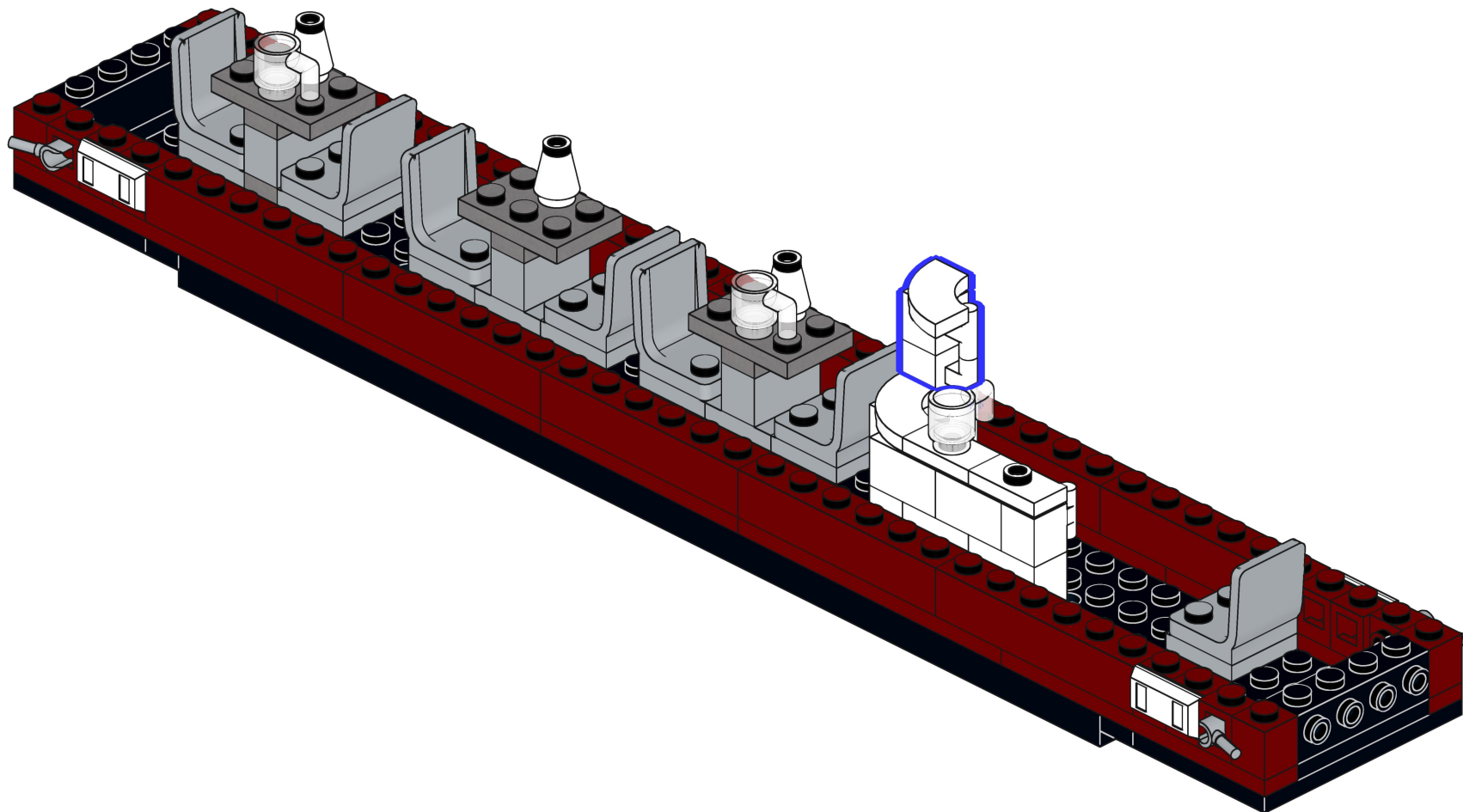

15

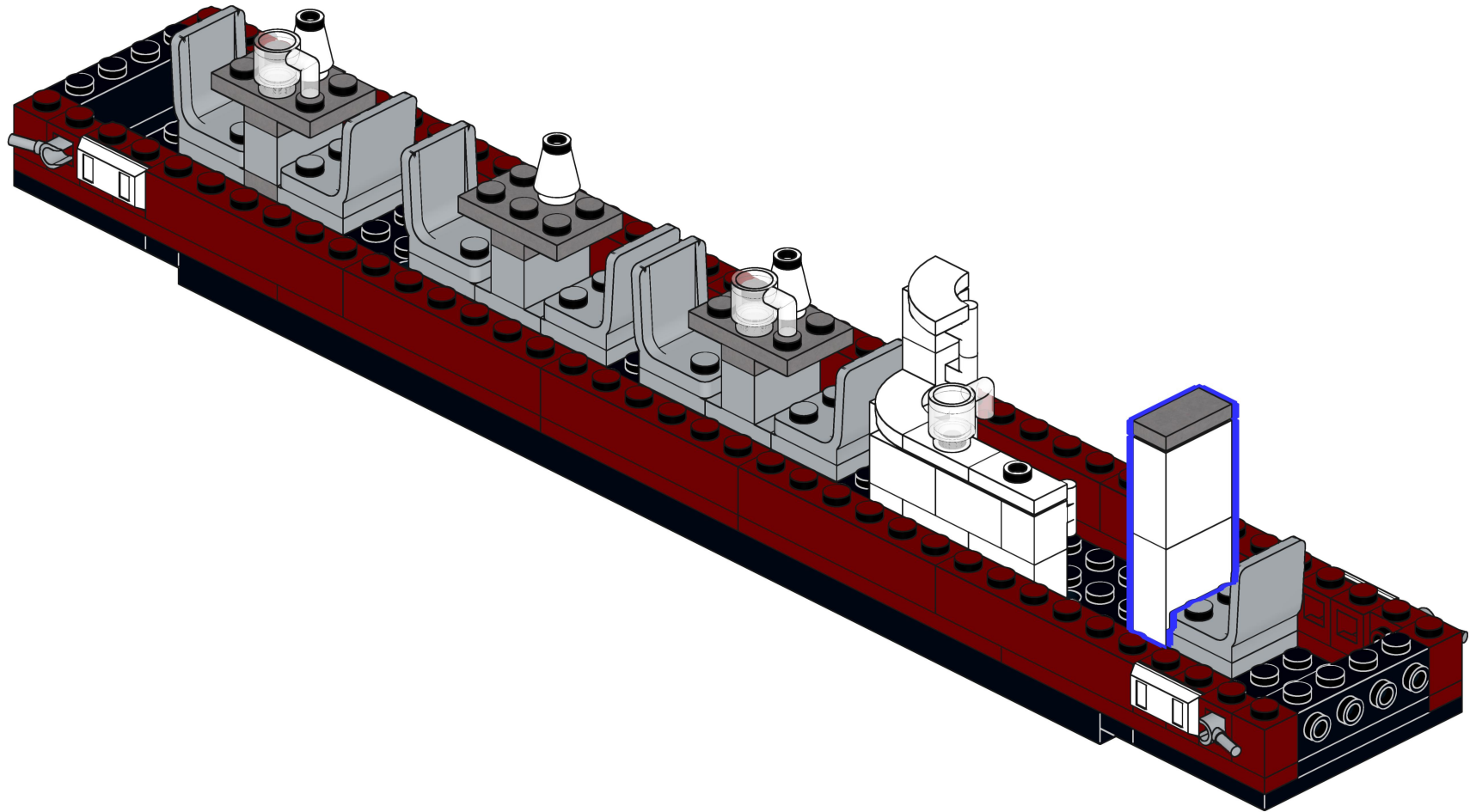
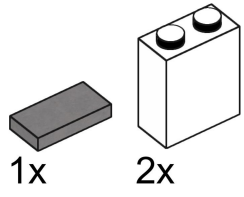

16

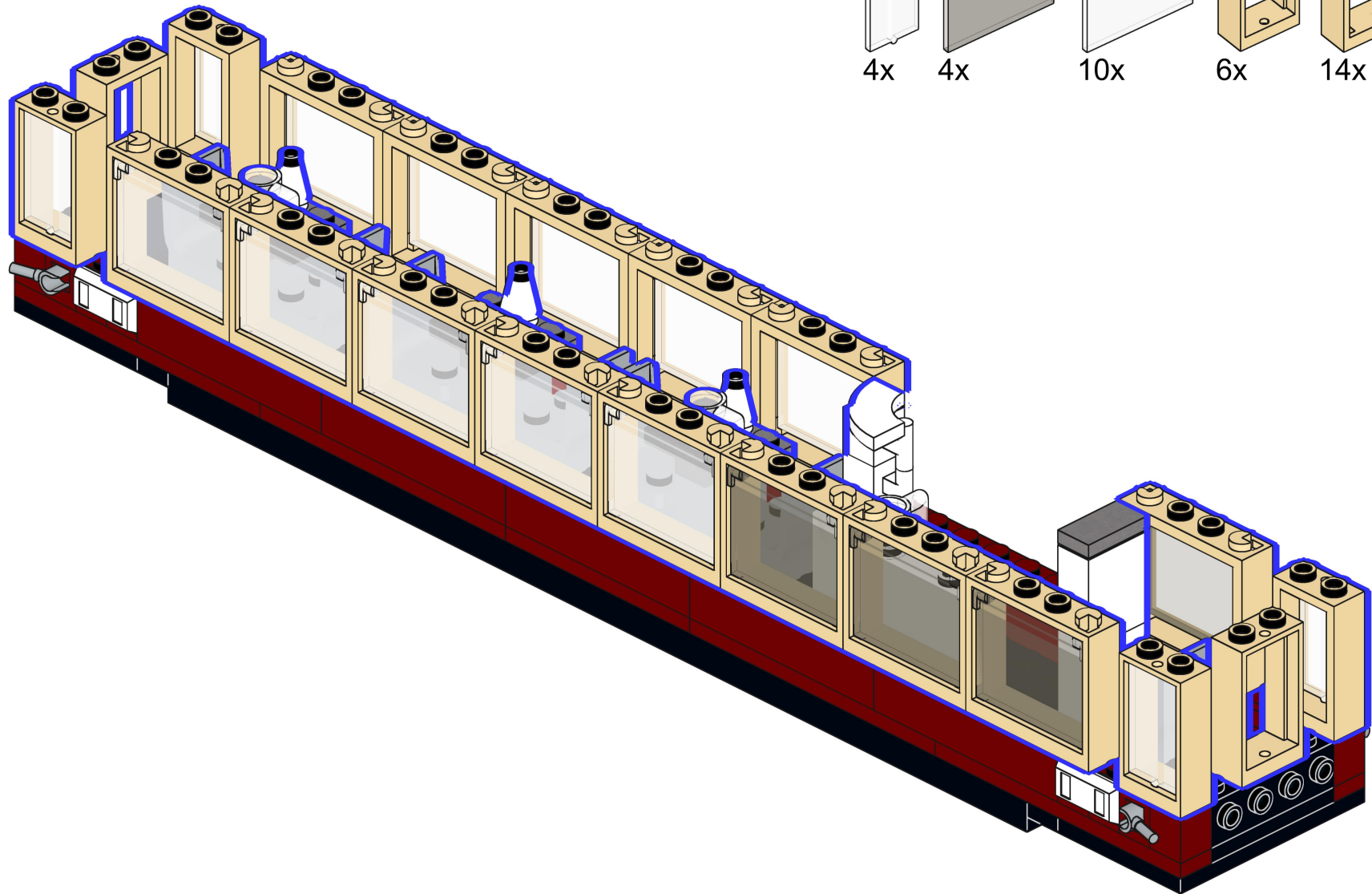

17

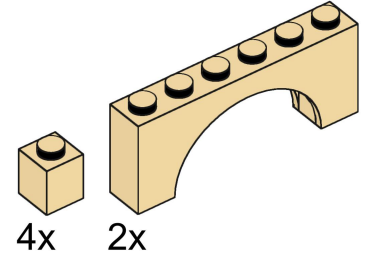
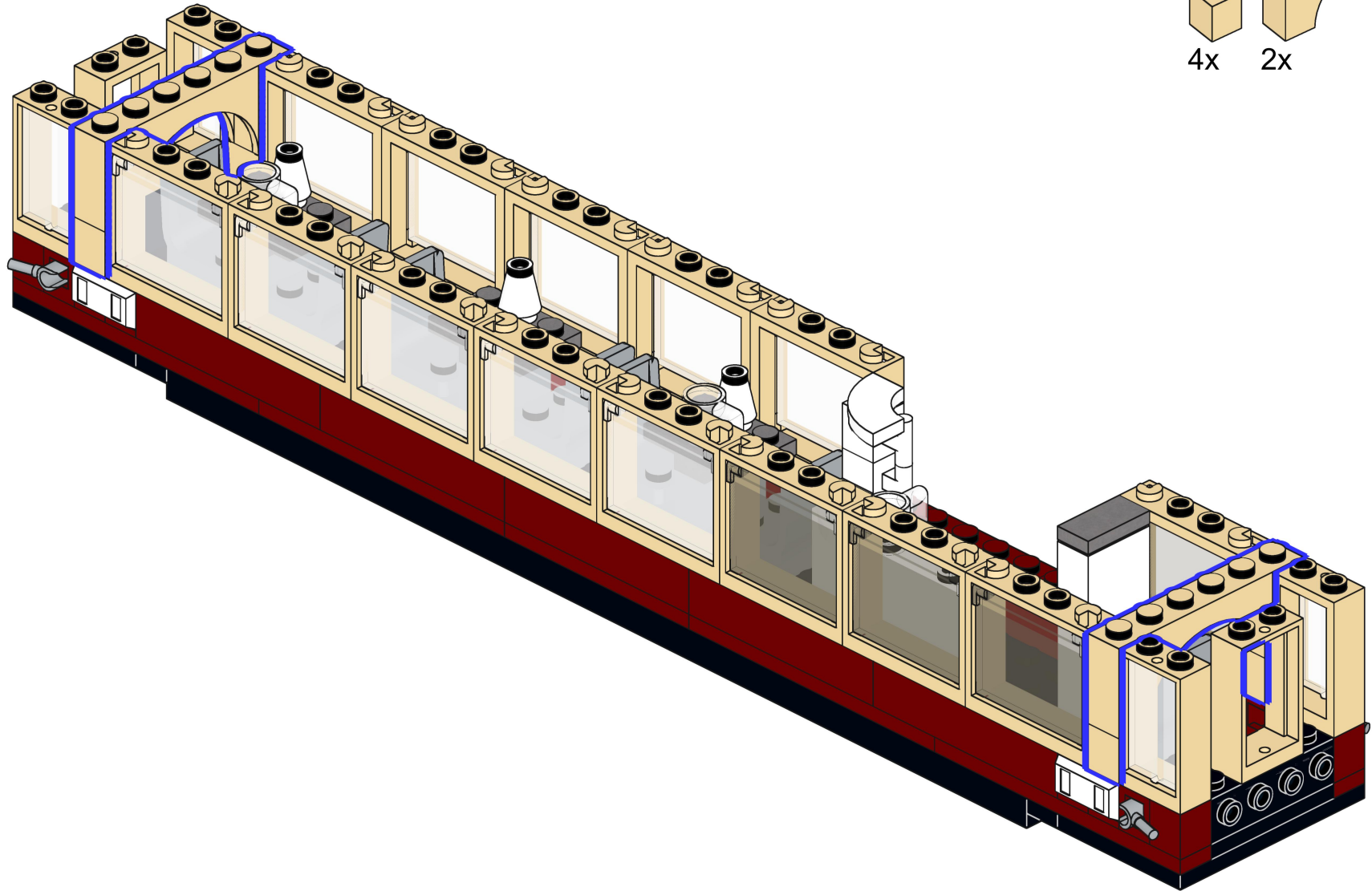

18

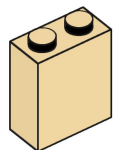

4x

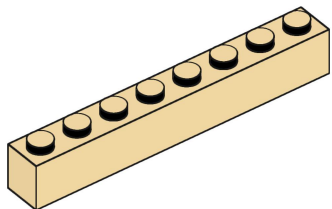

1x

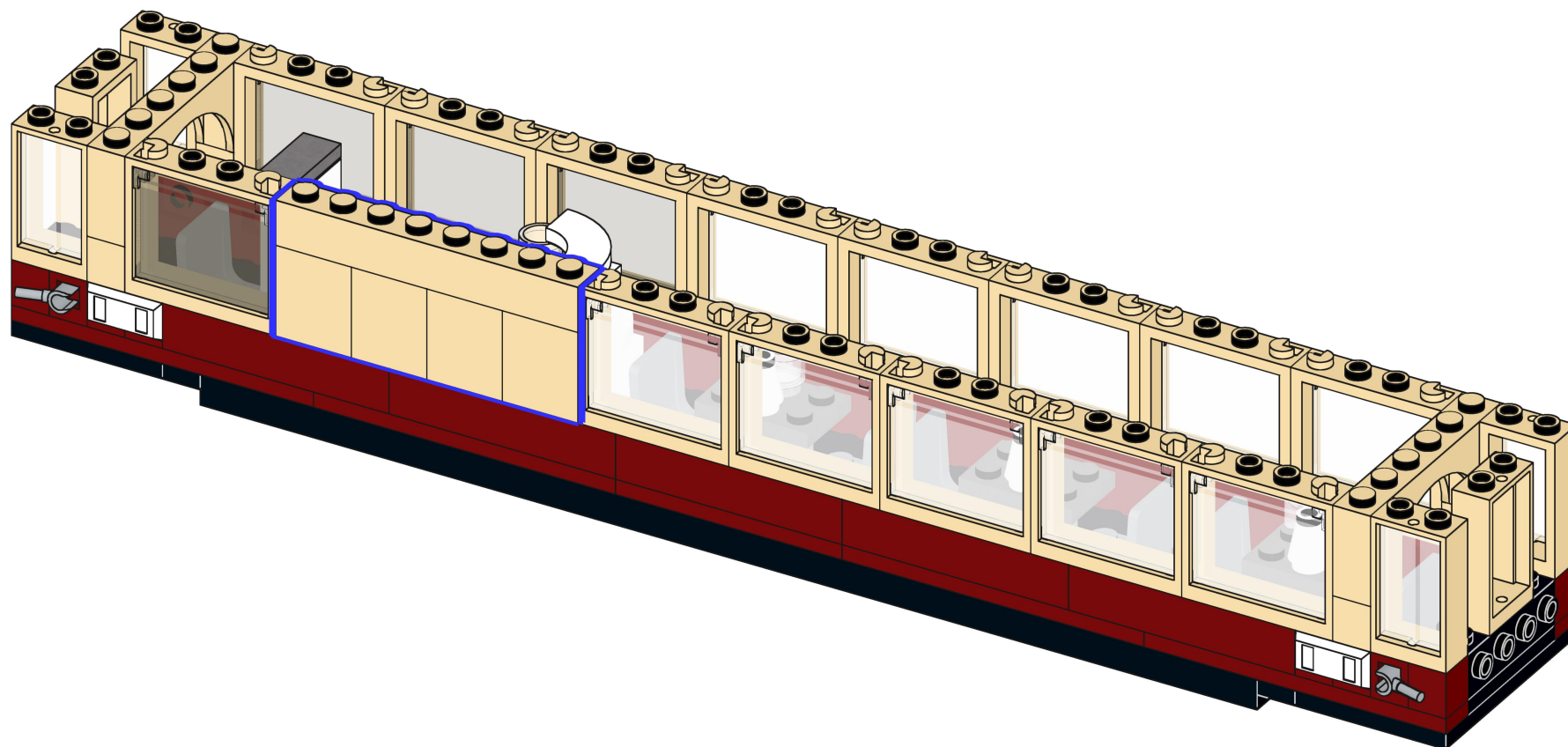

19



1x



2x

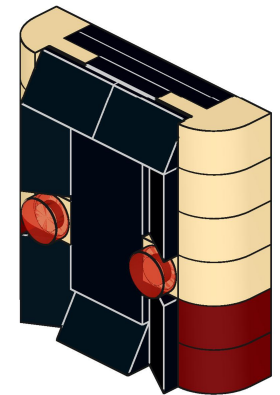
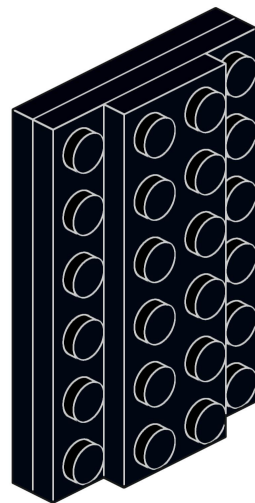

X2

20

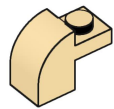

8x



4x

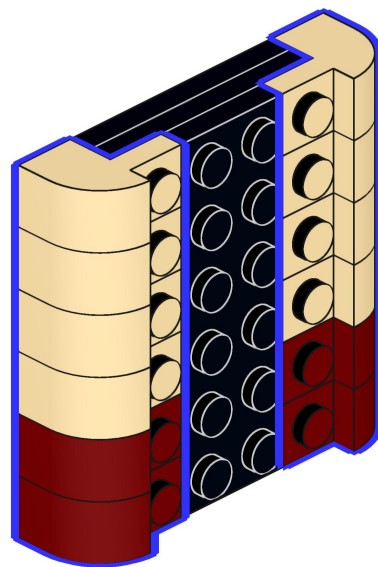

21



2x



2x

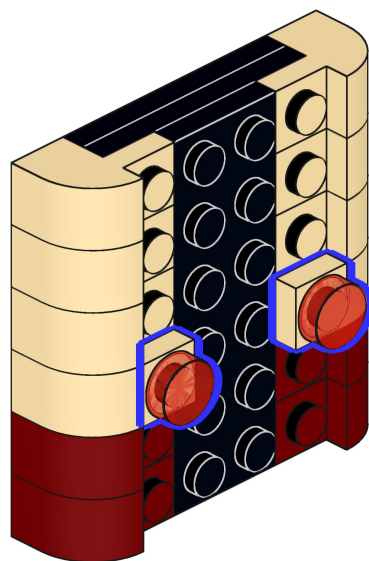

22

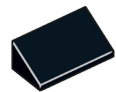

7x

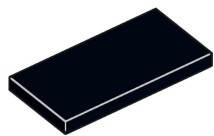

1x

X2

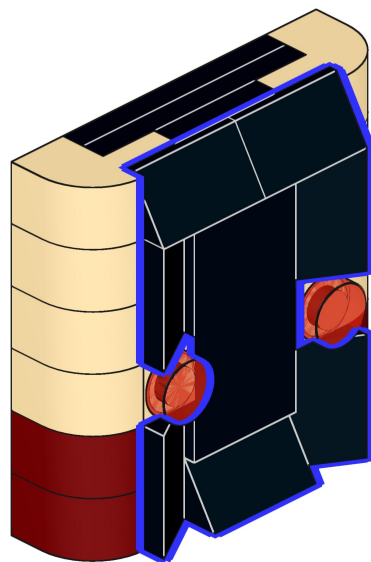

23

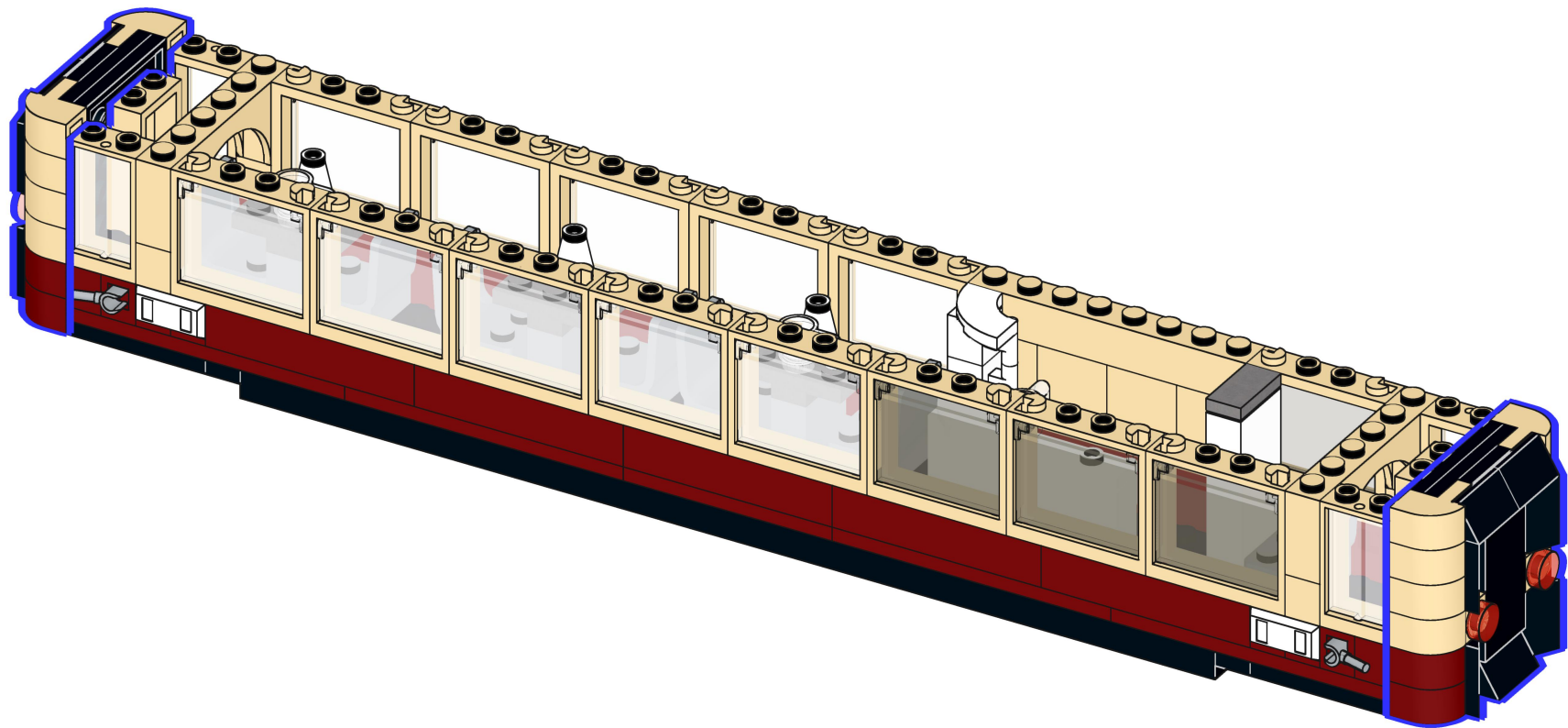

24

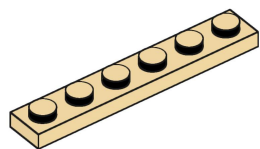

6x

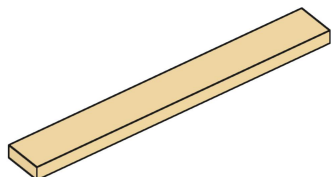

8x

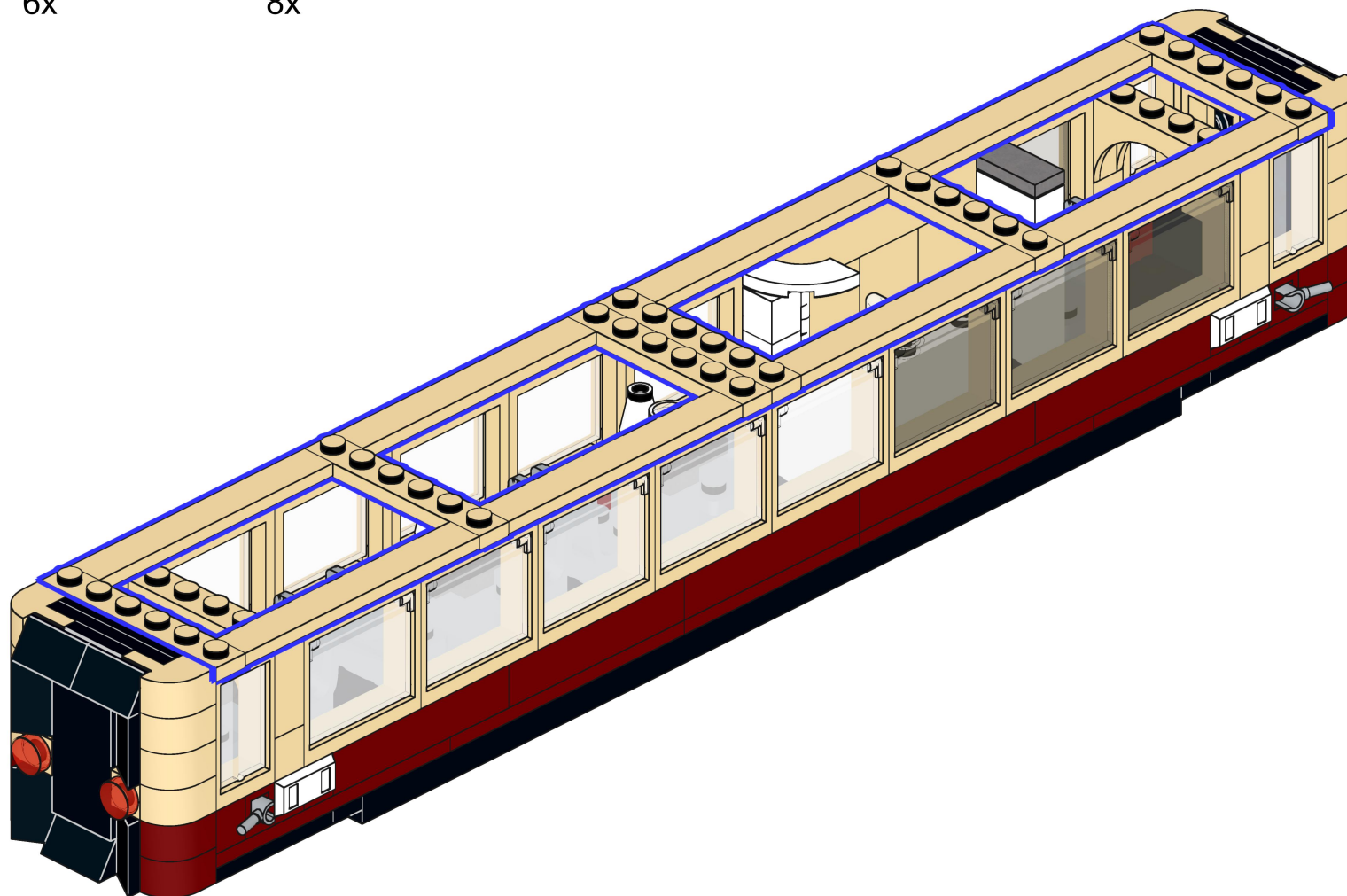

25

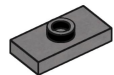

6x

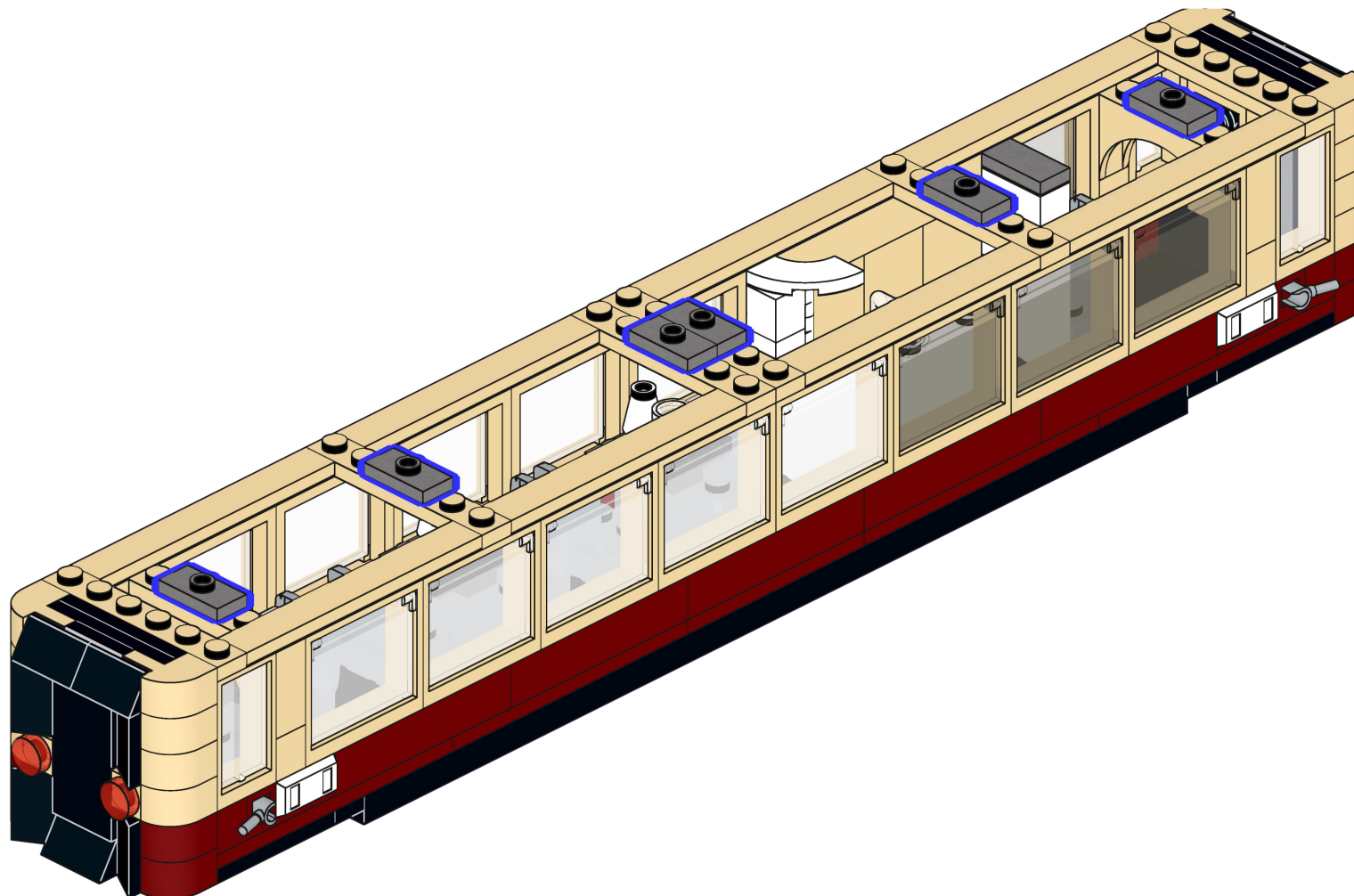

26

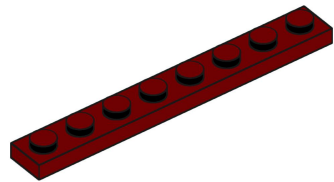

4x

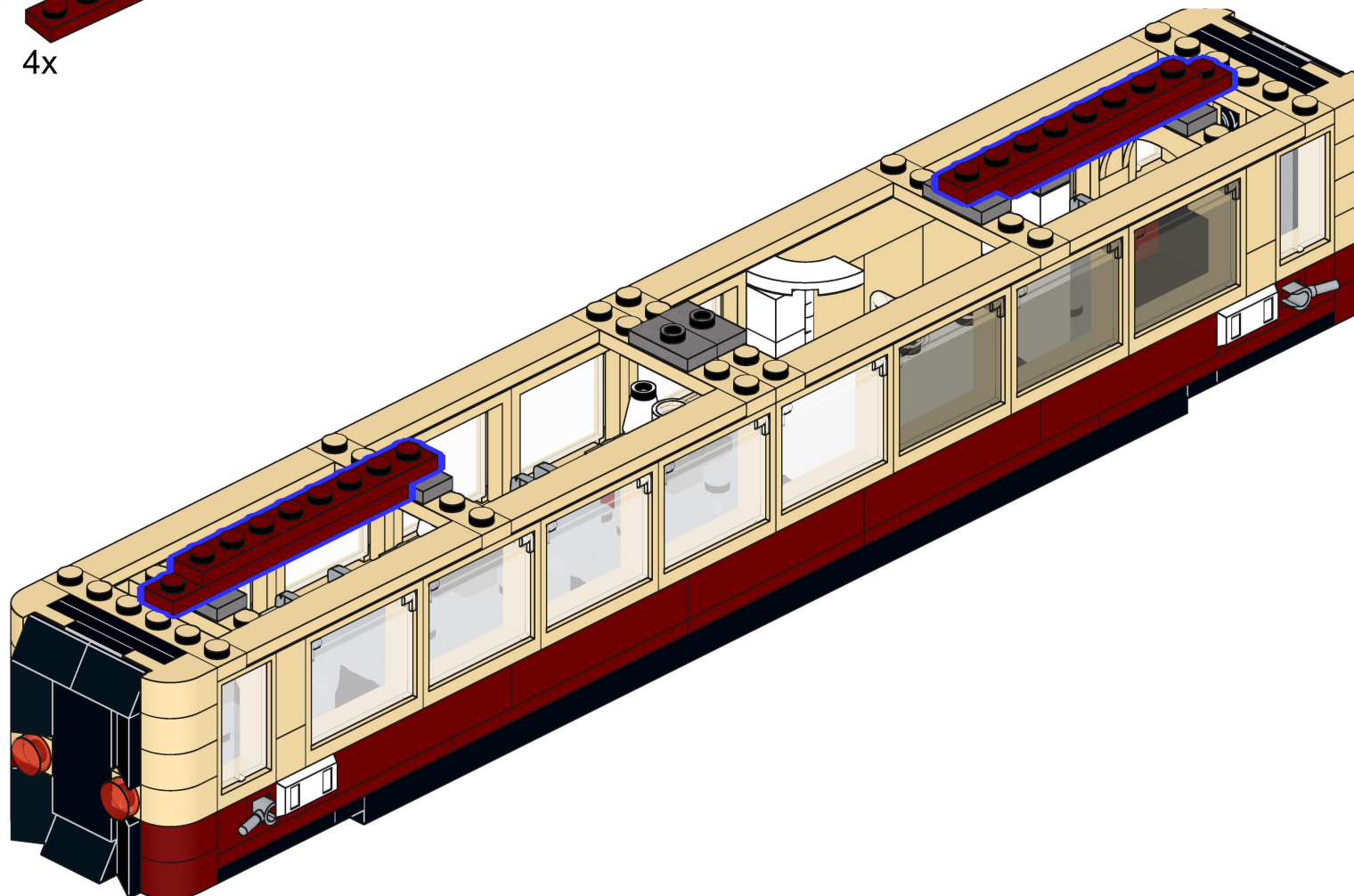

27

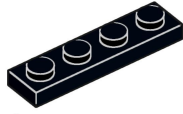

1x

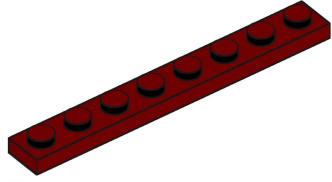

5x

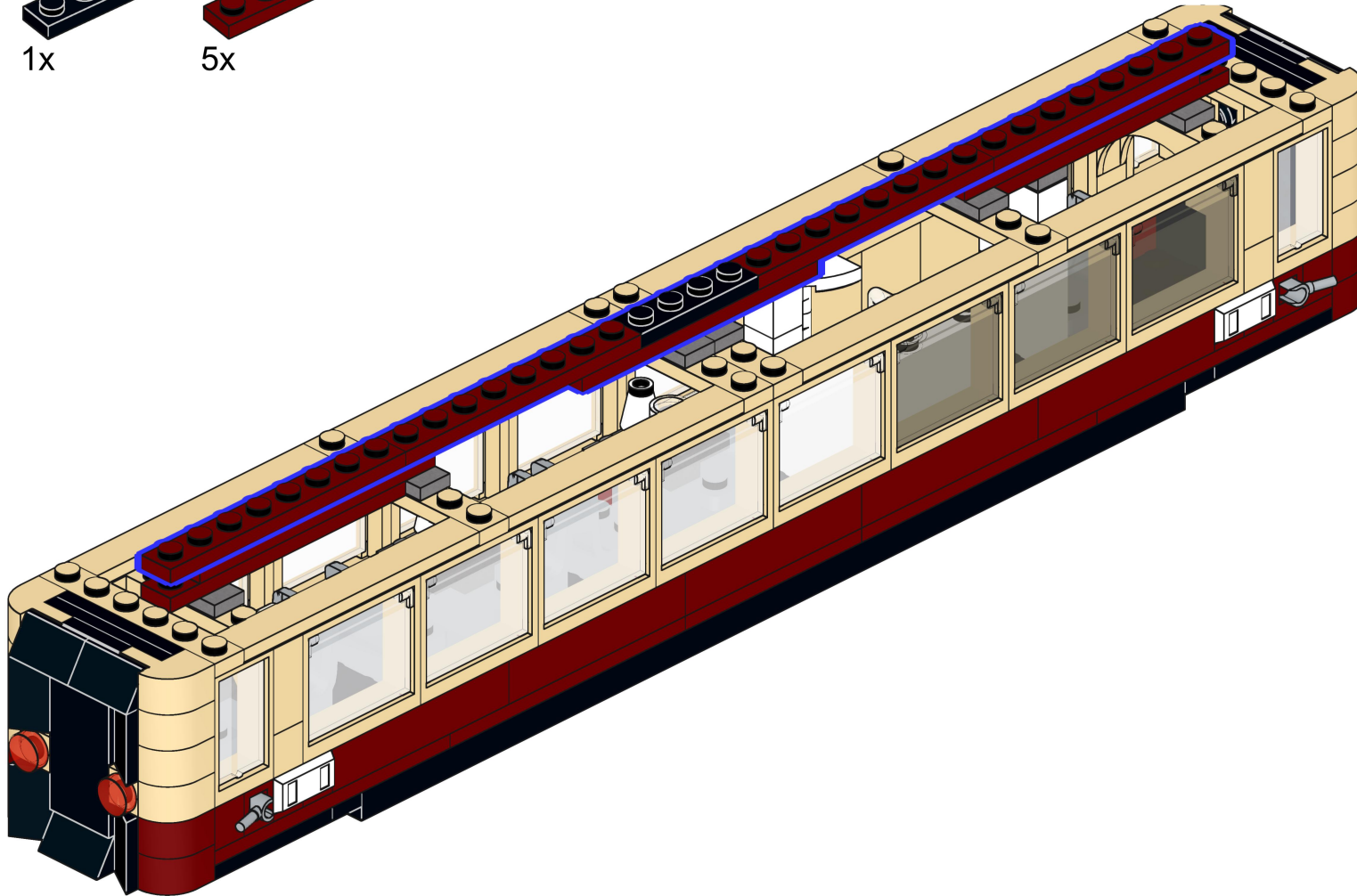

28

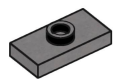

2x

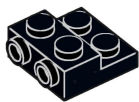

2x

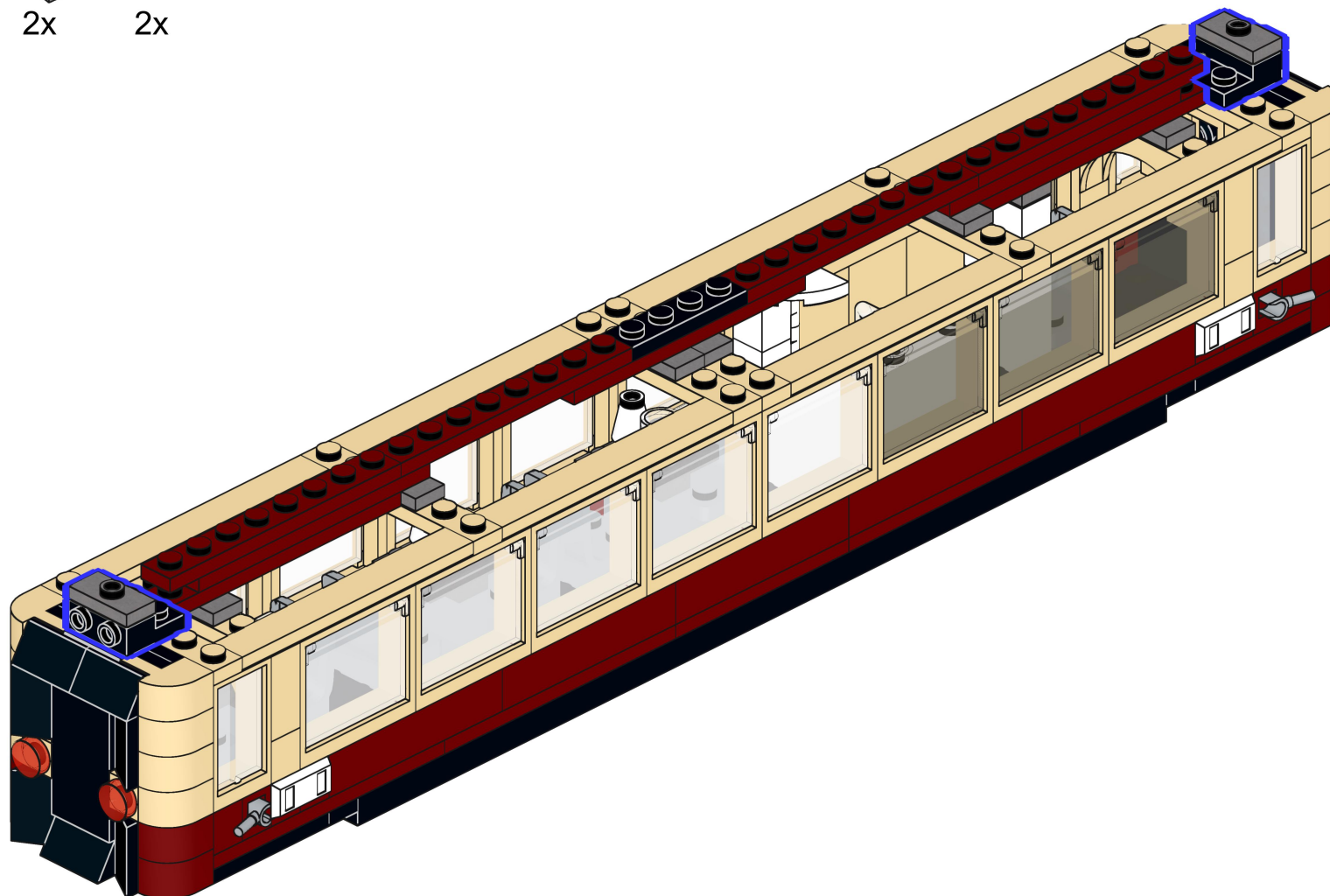

29



11x

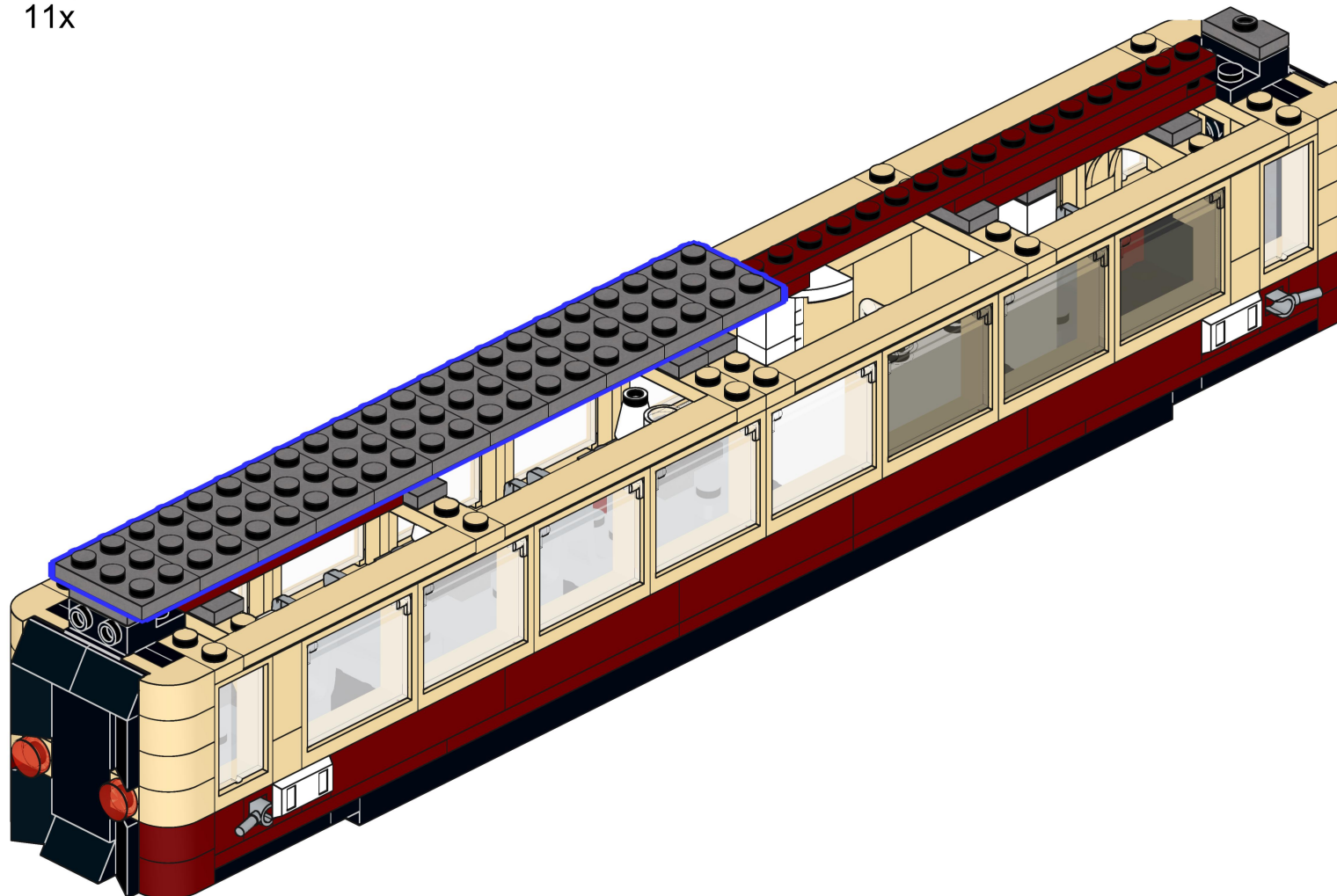

30

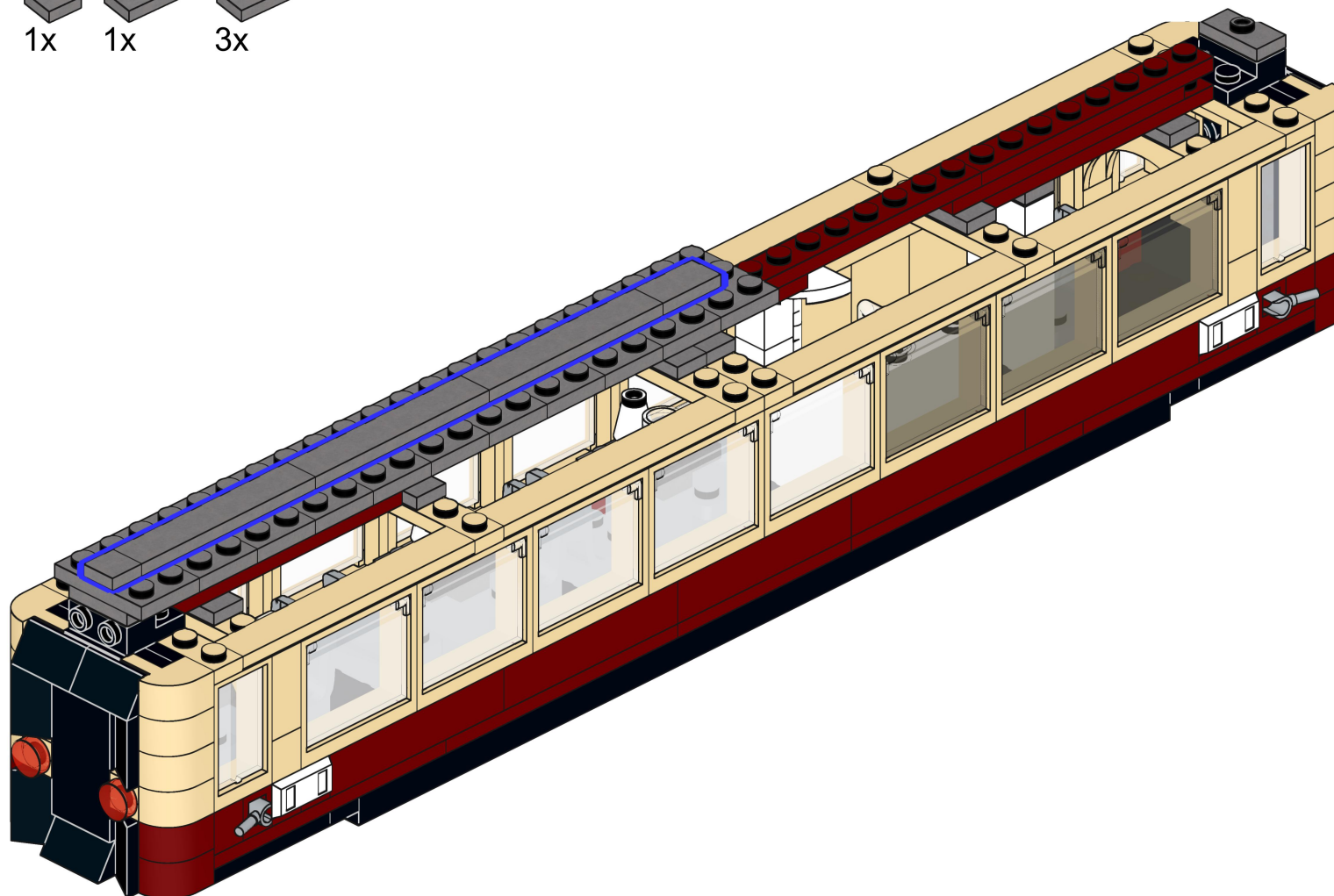
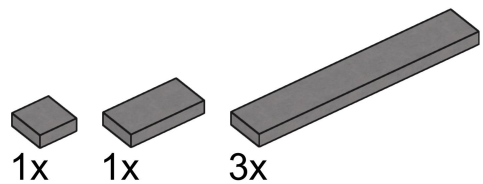

31

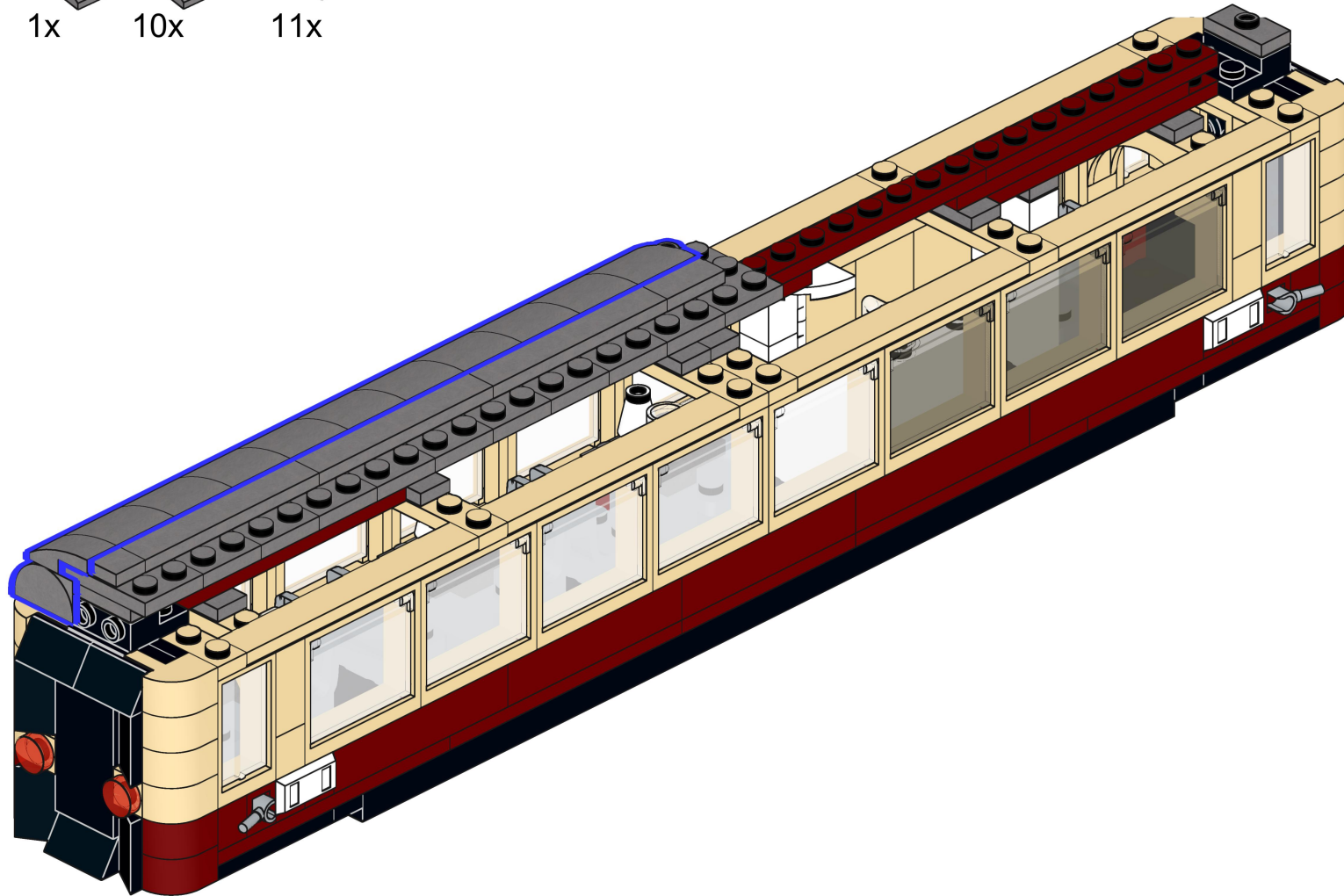
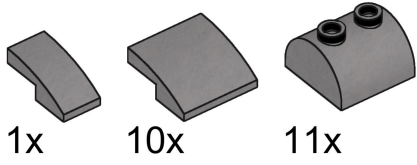

32

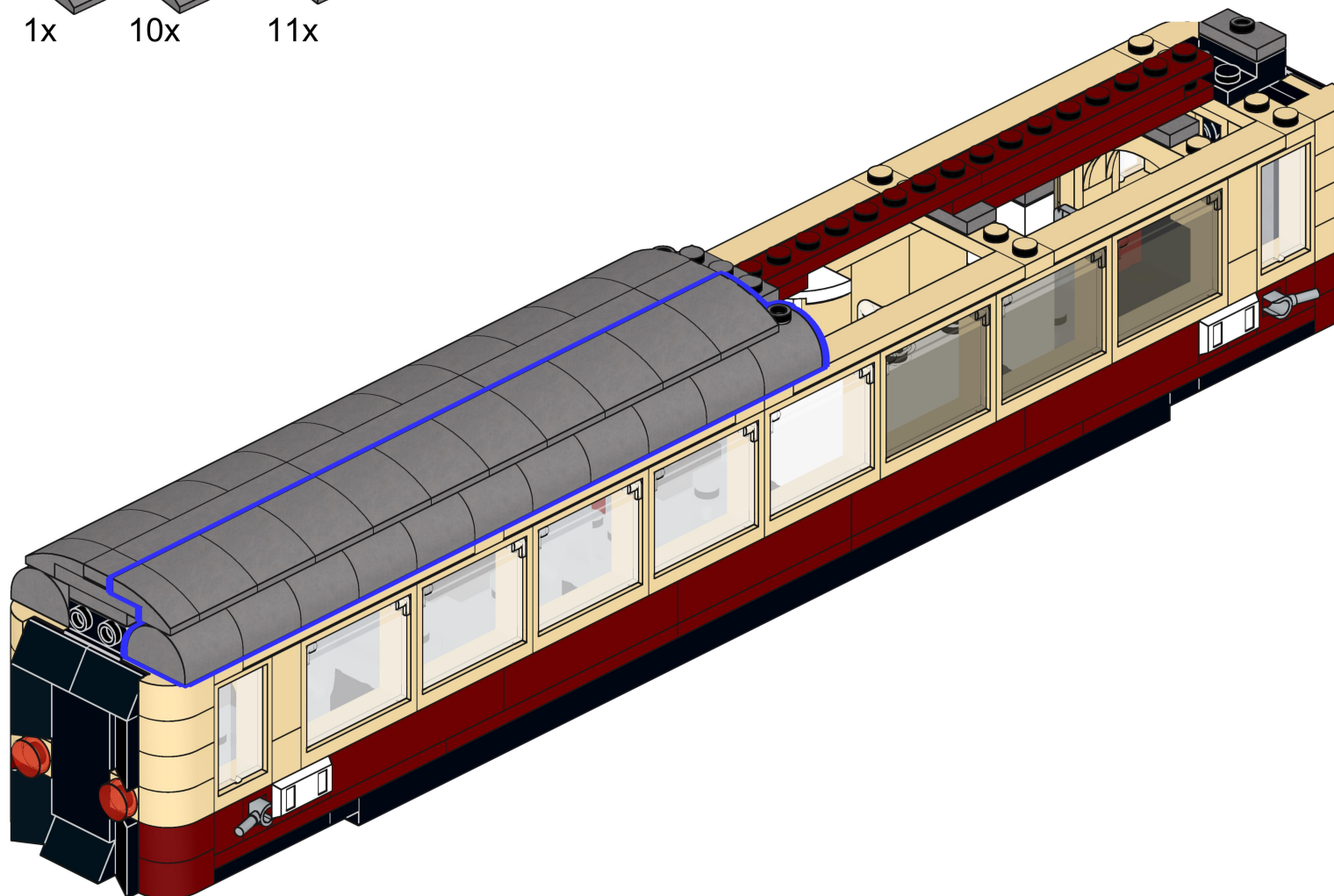
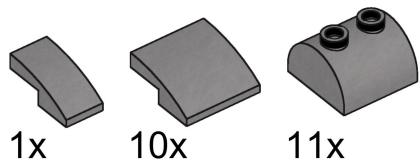

33



8x

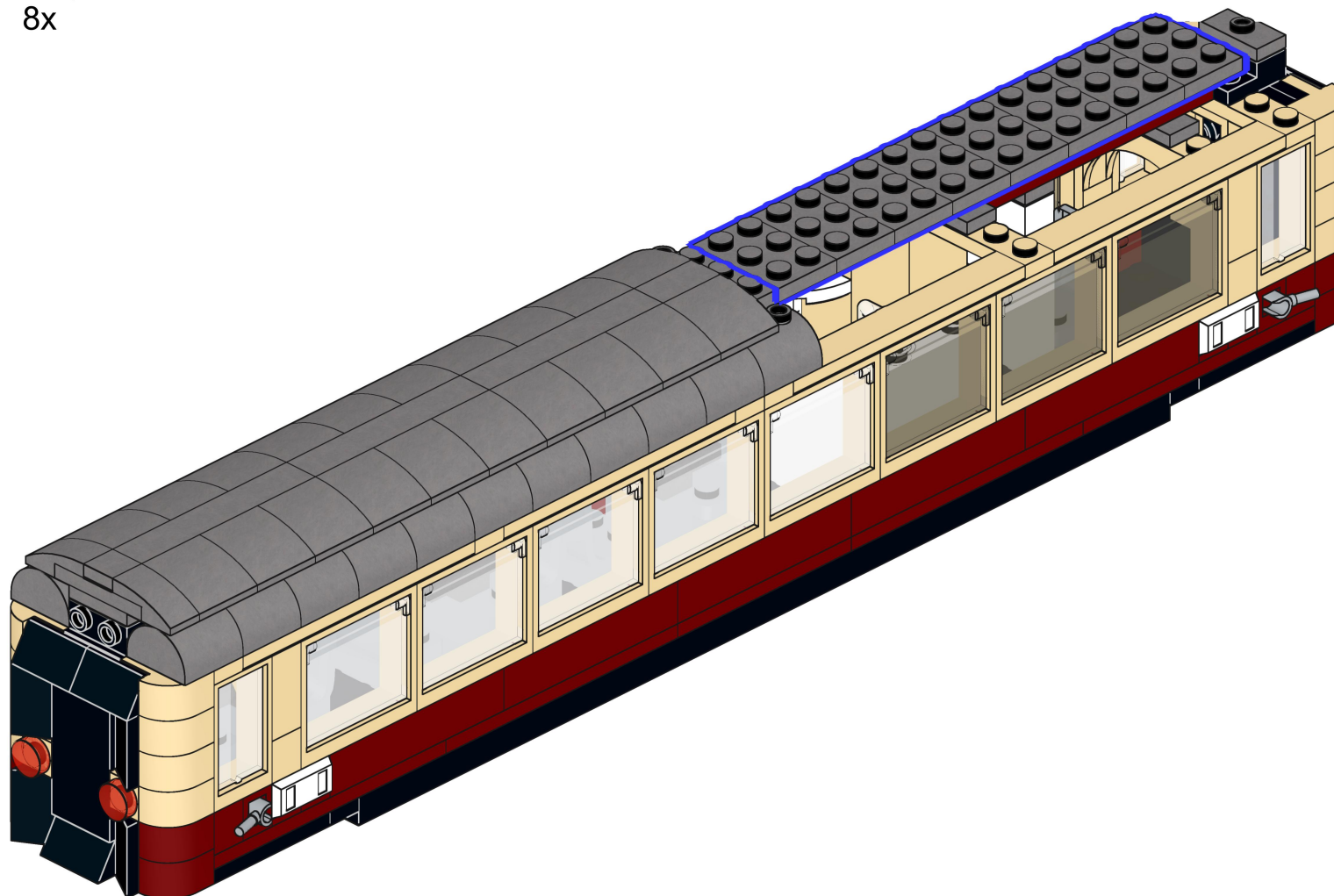

34

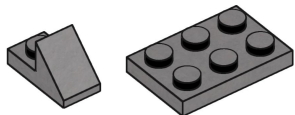

6x

13x

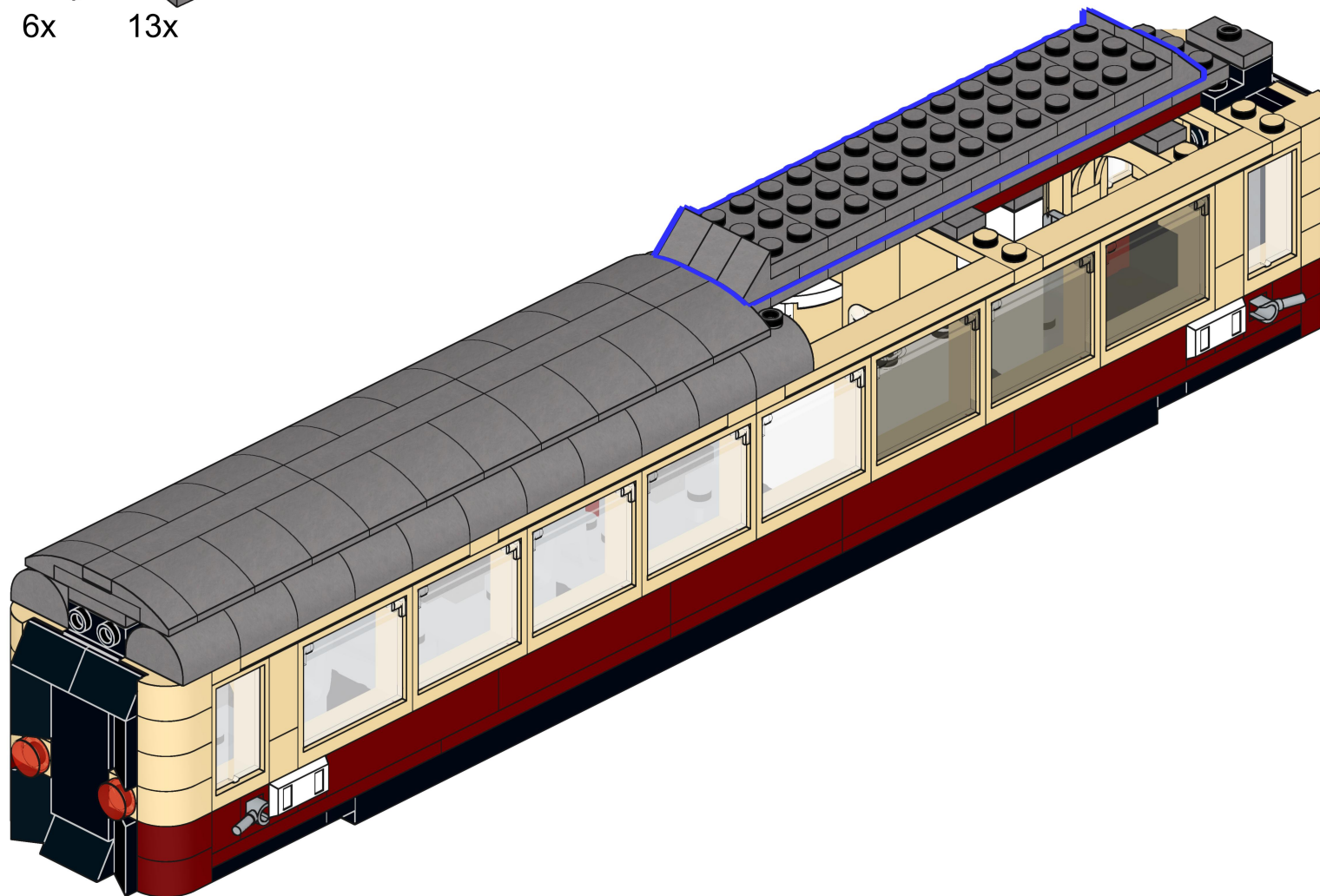

35

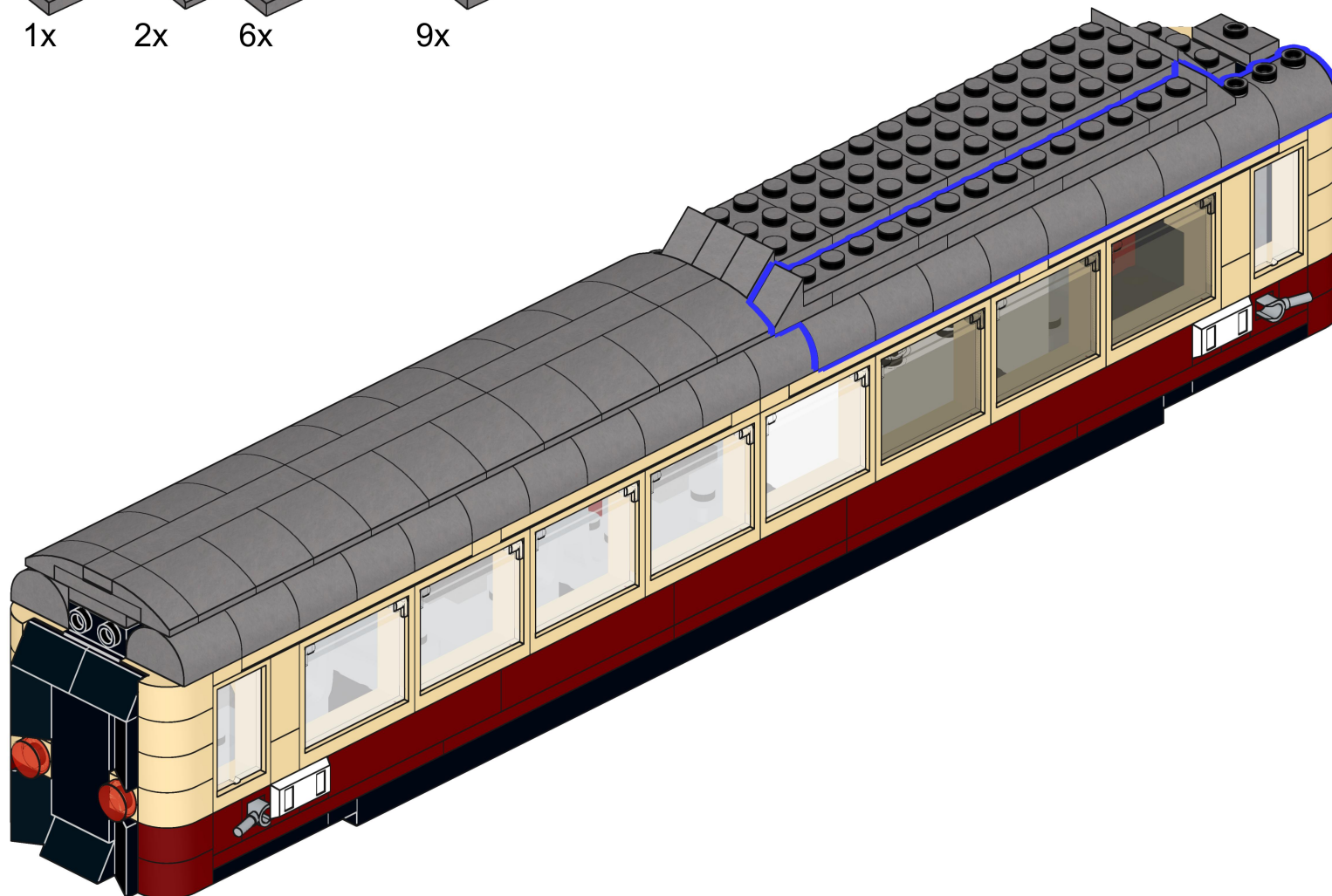
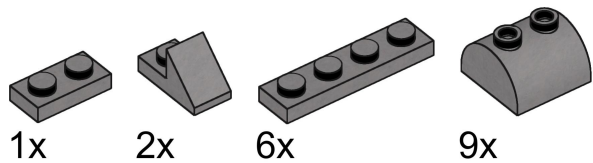

36

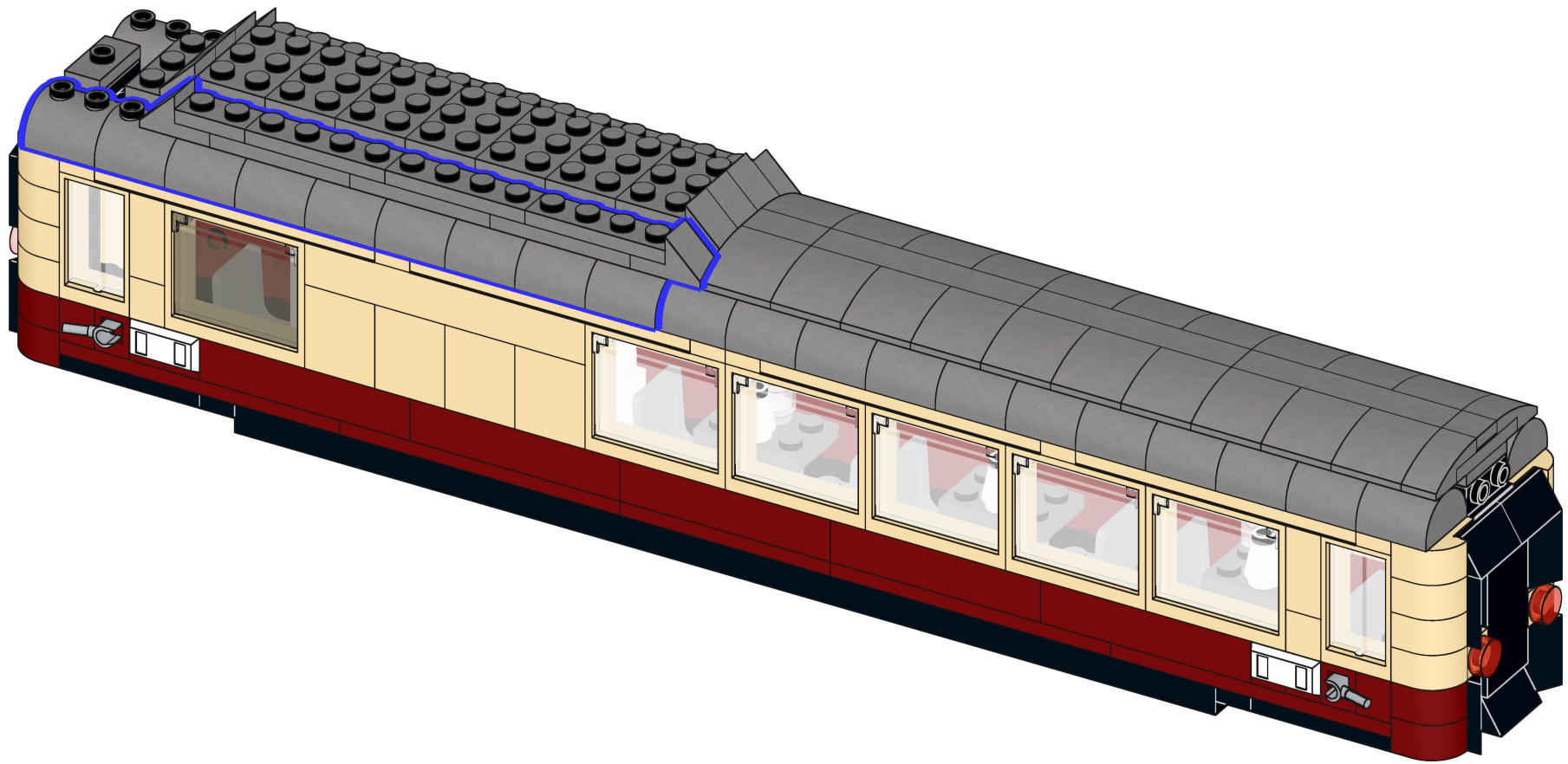
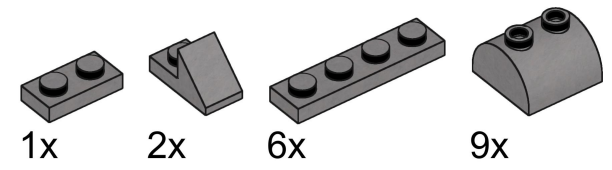

37



2x

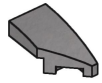

2x



2x

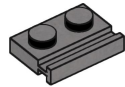

4x

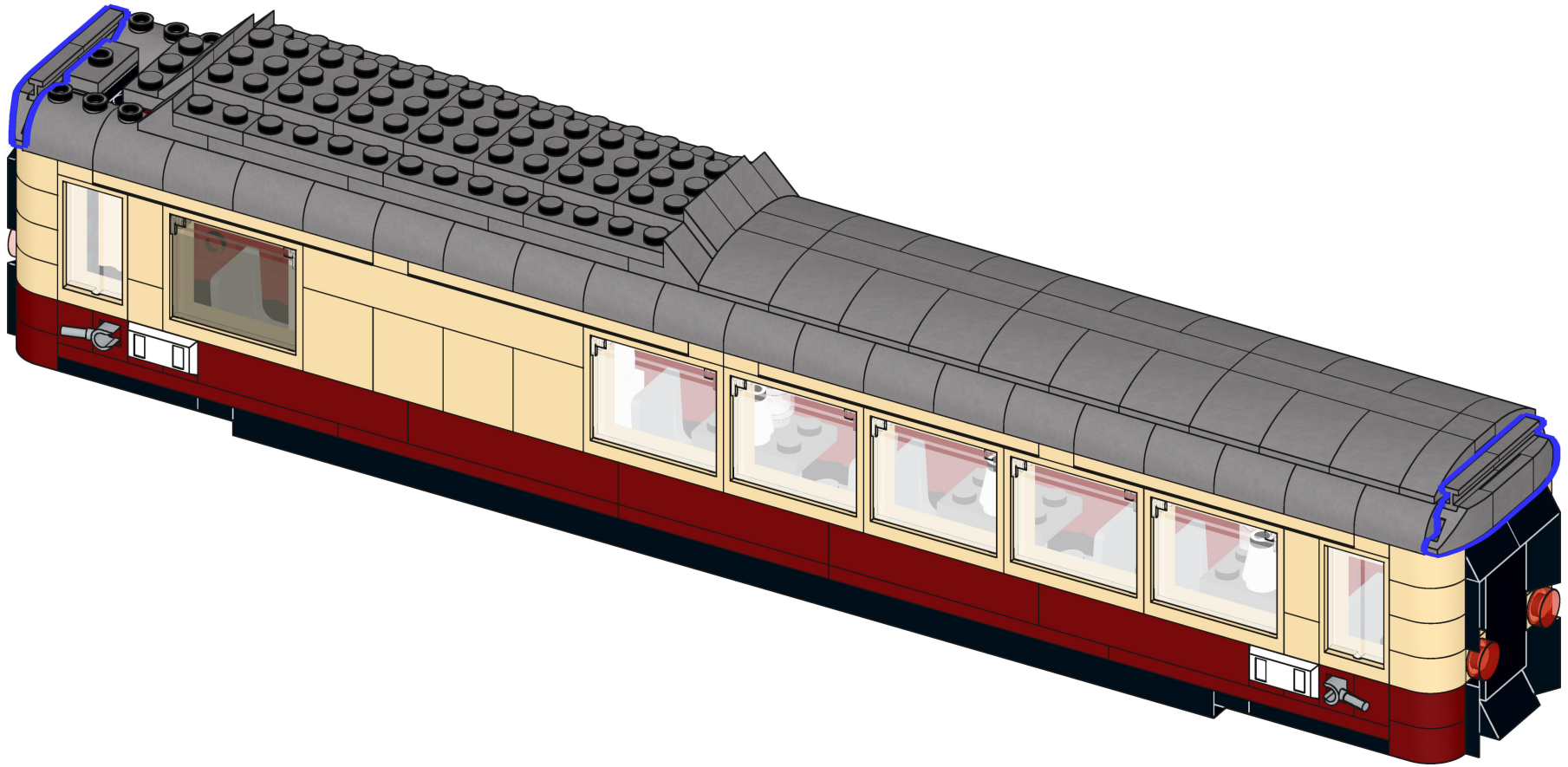

38

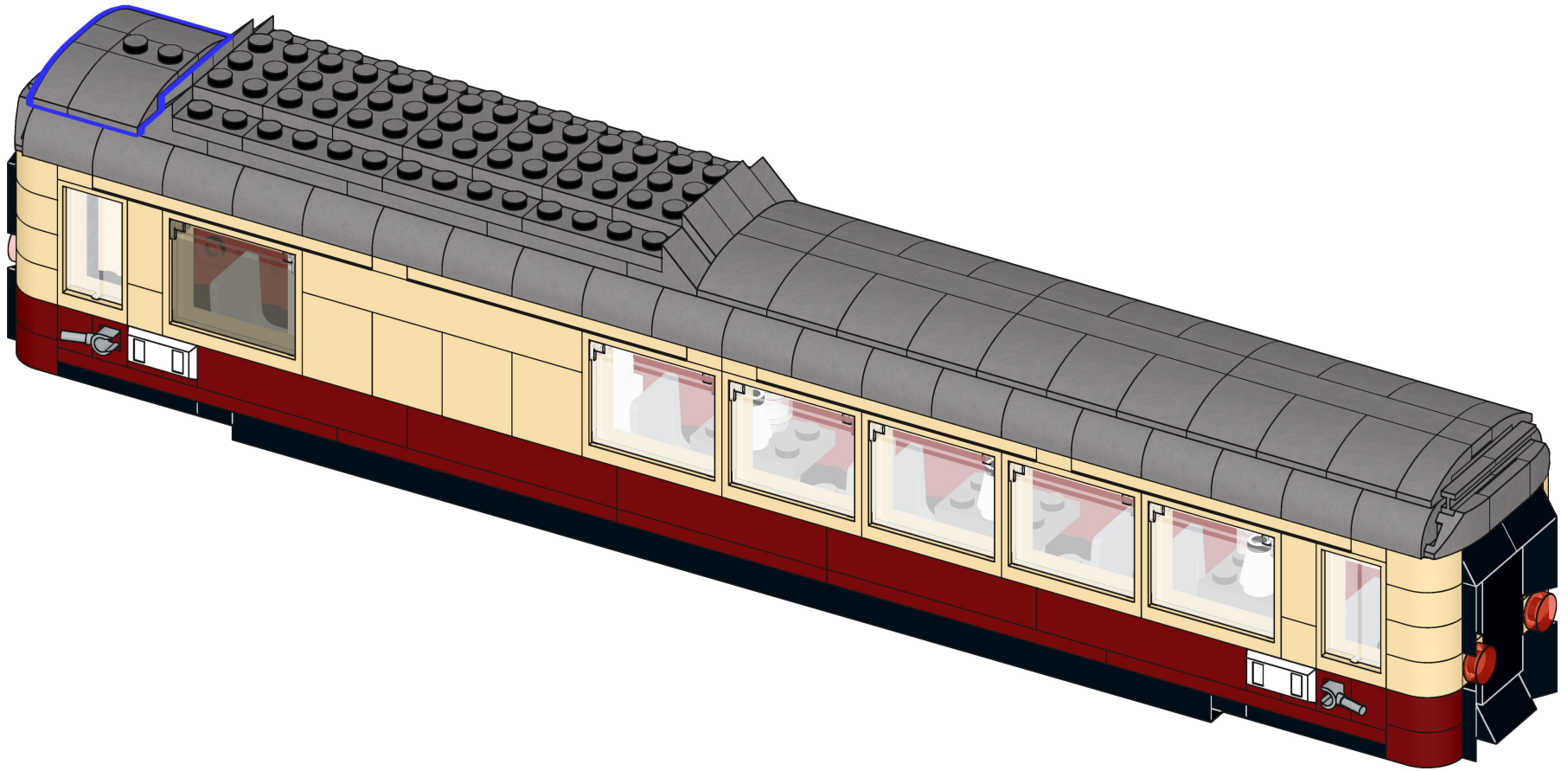
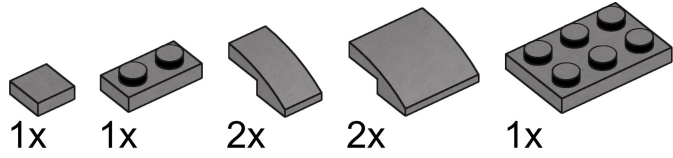

39

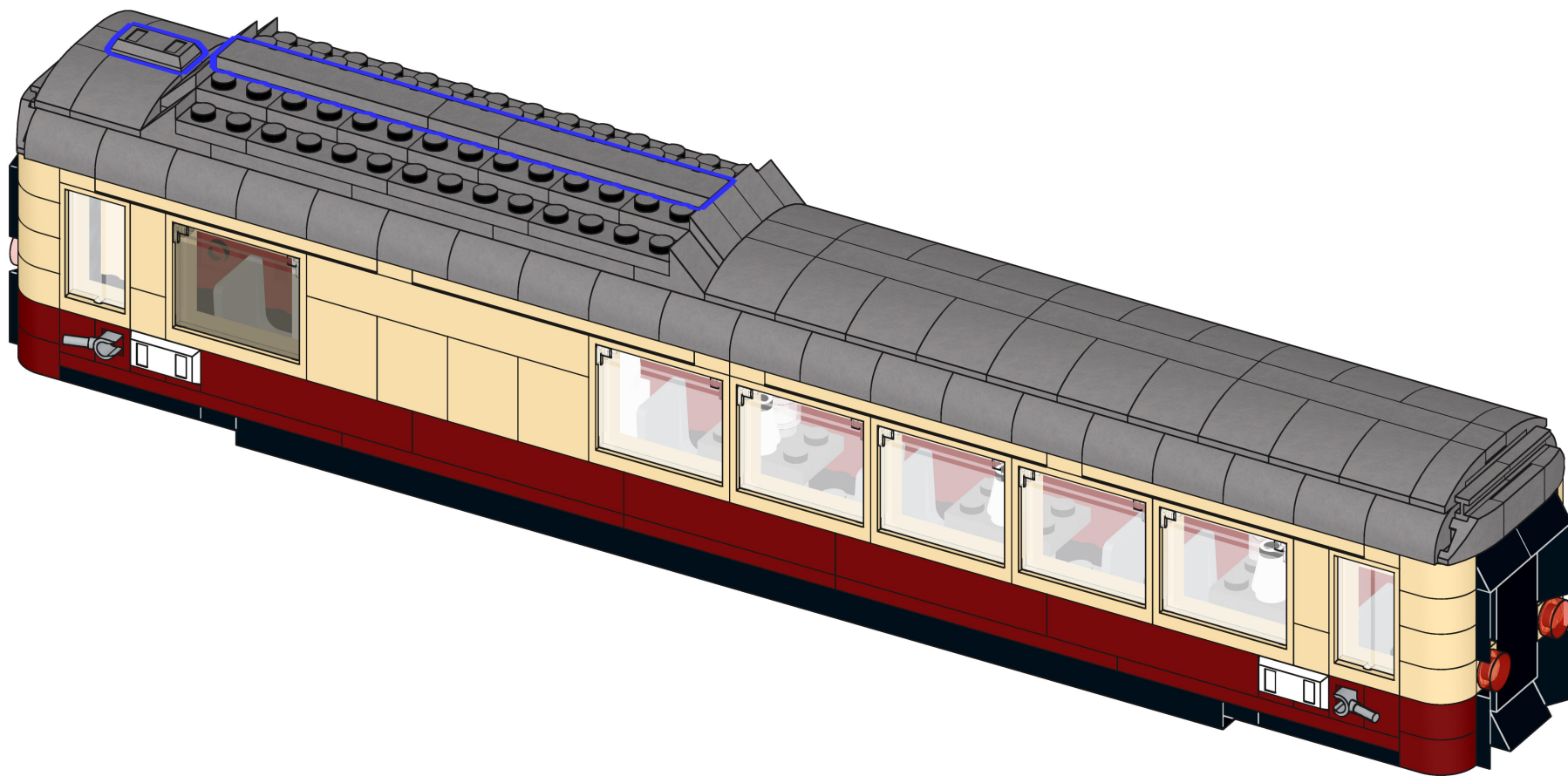
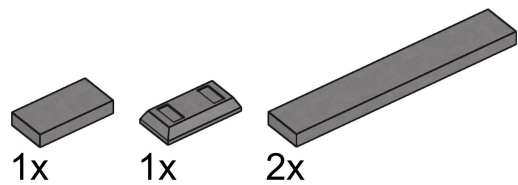

40

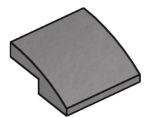

14x

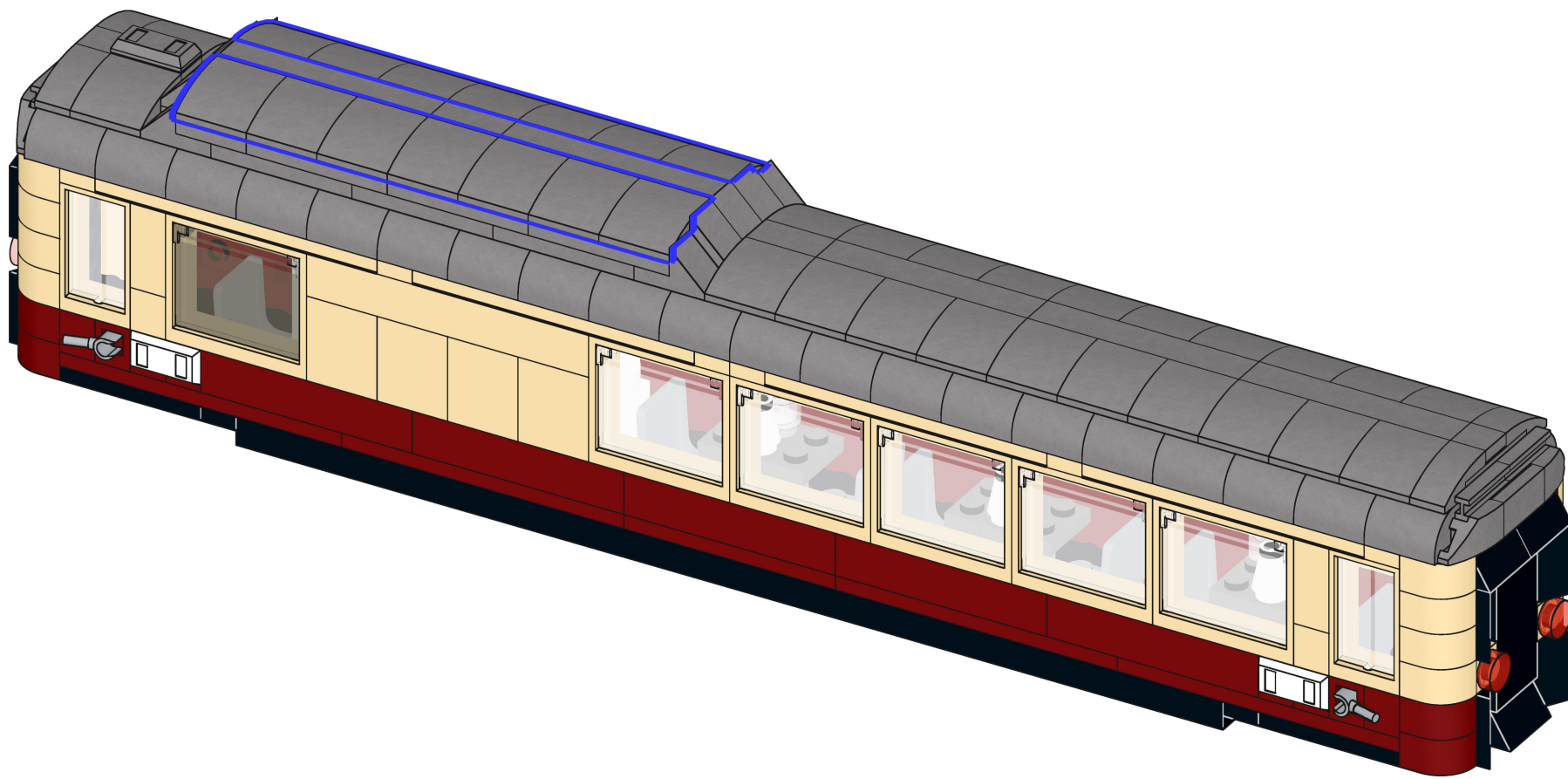

41

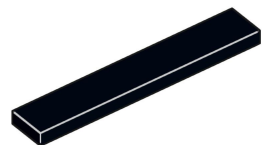

8x

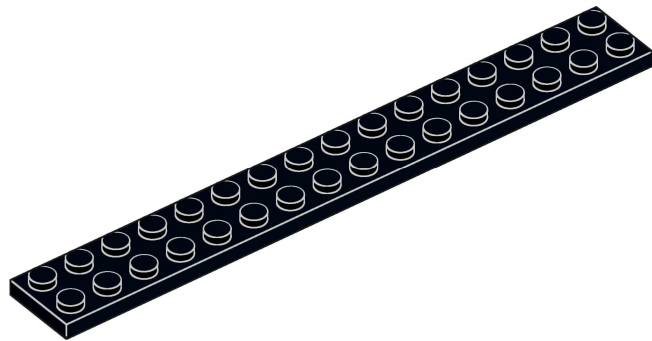

2x

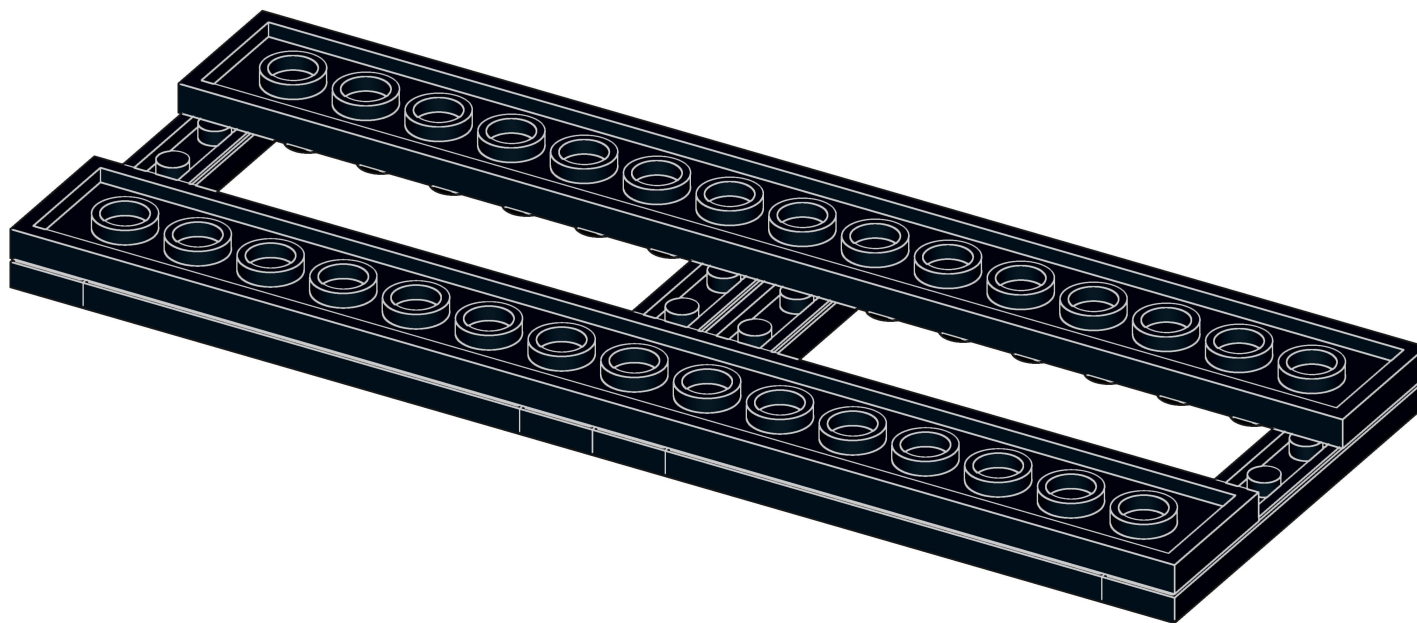
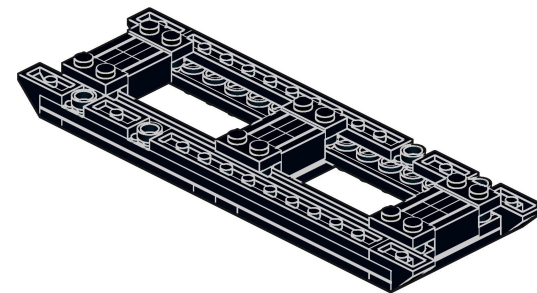

42

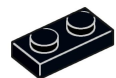

2x



4x



4x

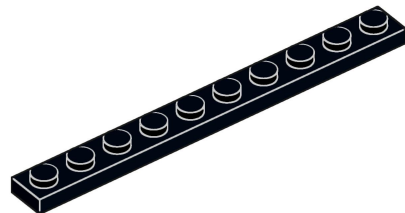

2x

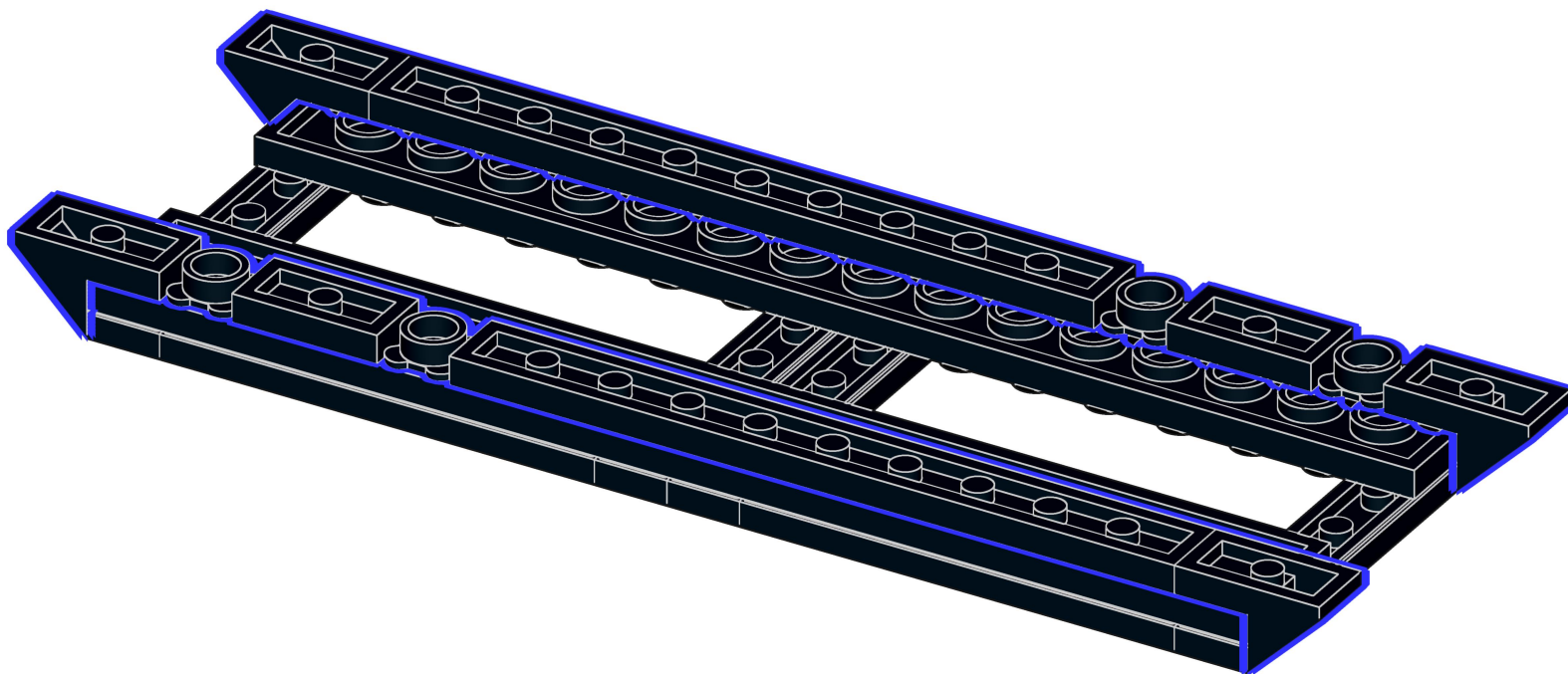

43

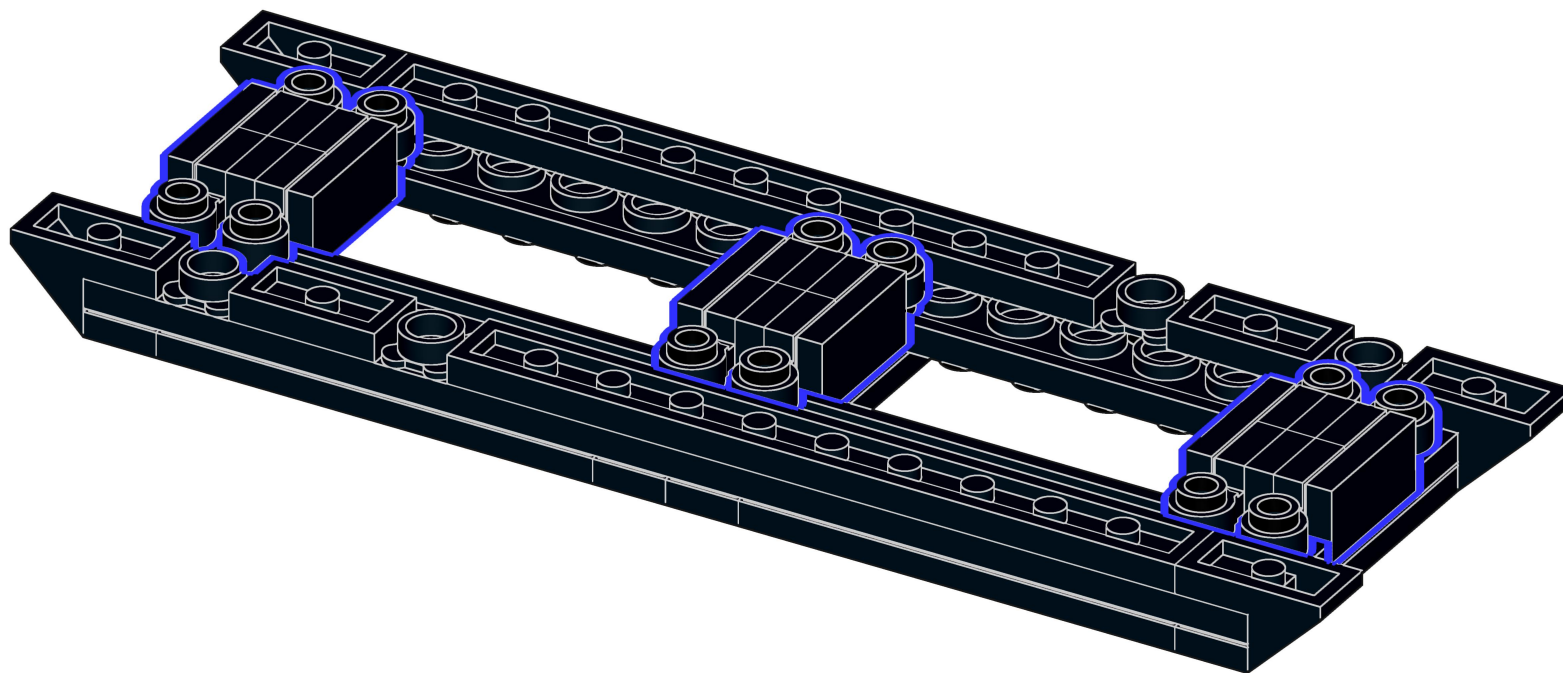
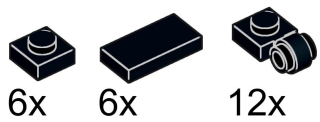

44

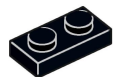

6x

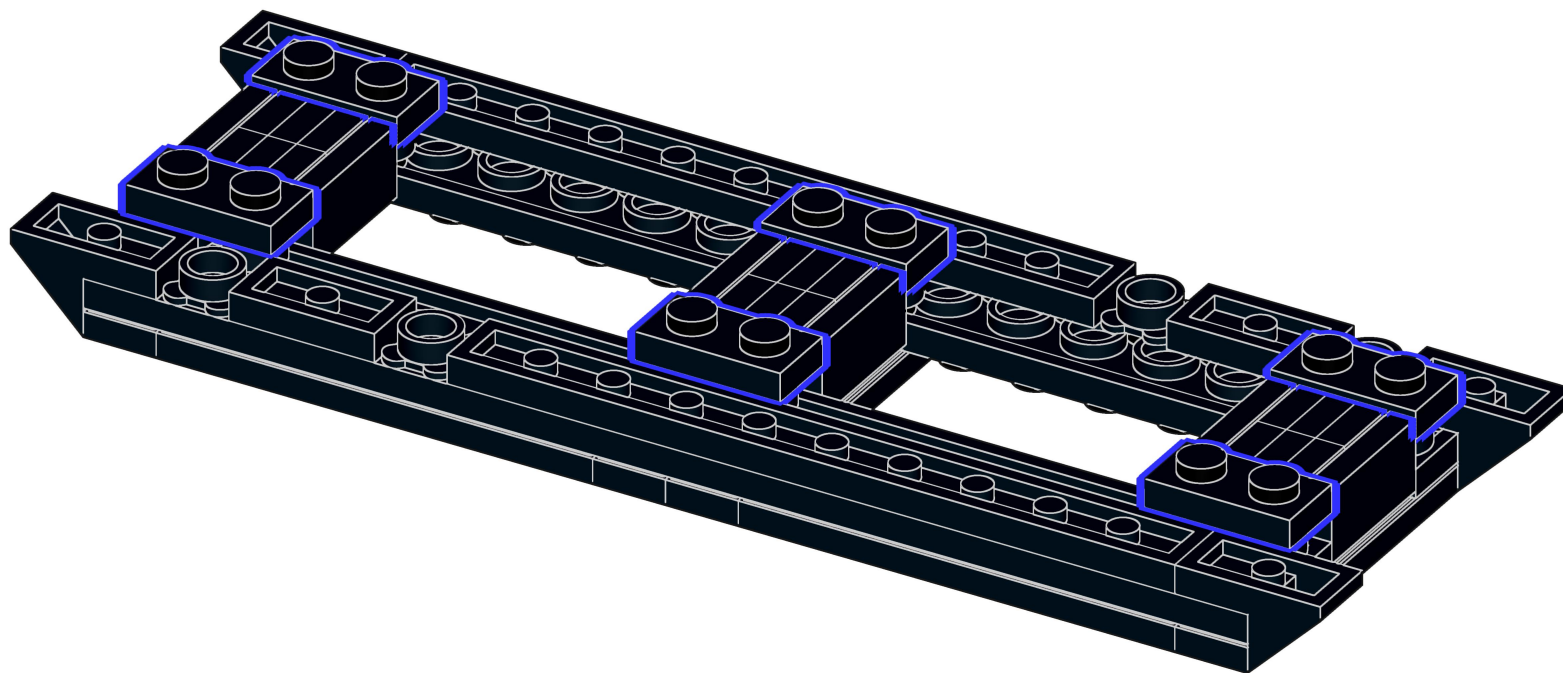

45

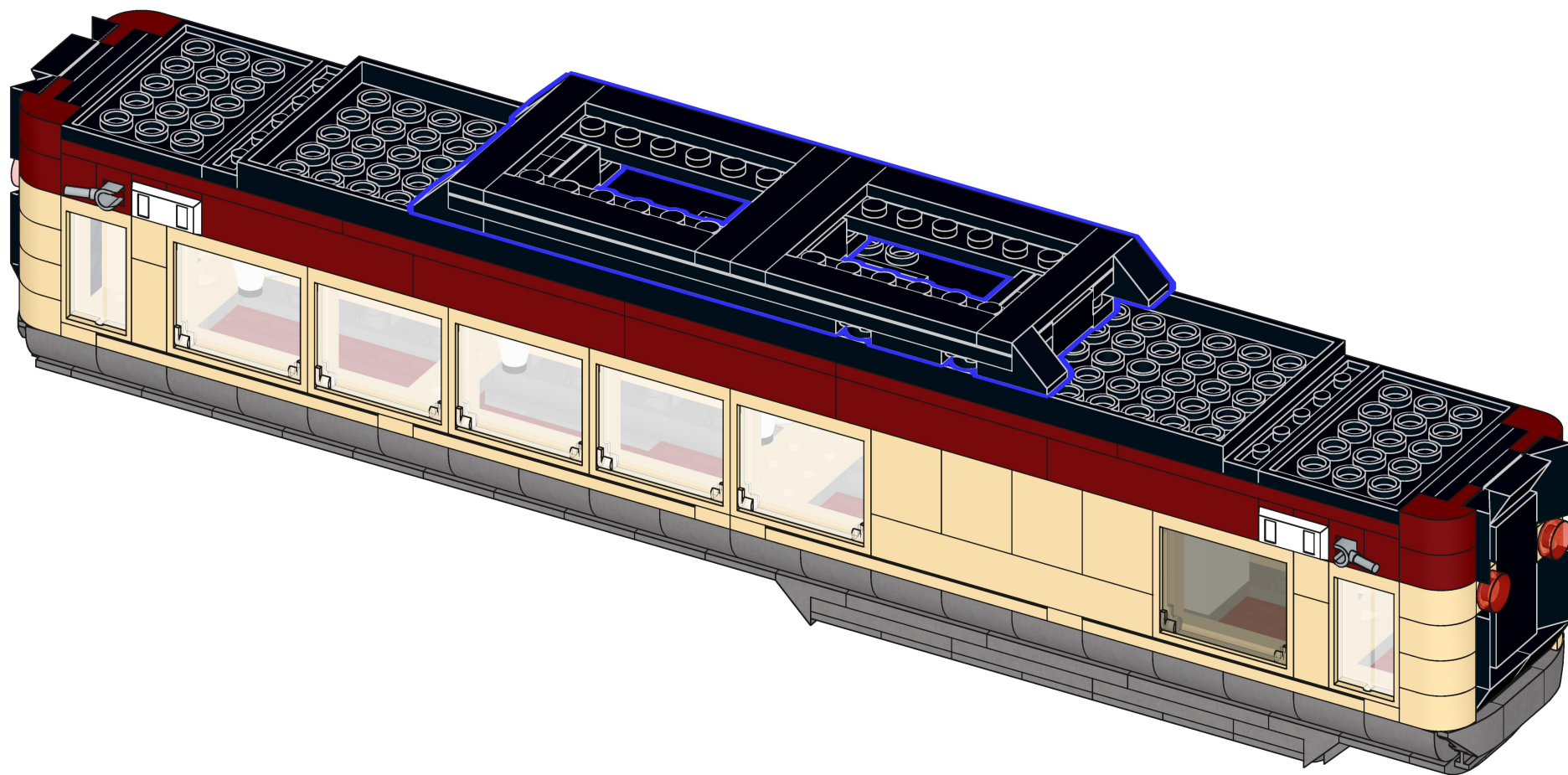

46

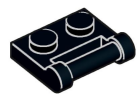

2x

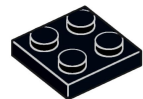

1x



4x

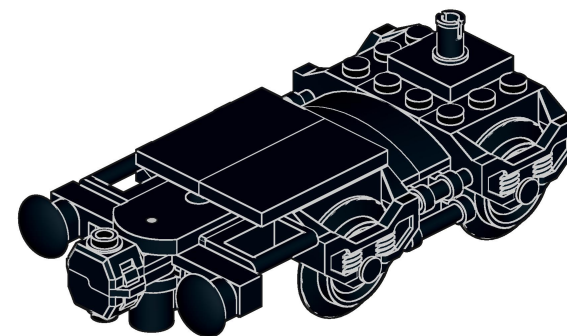

X2

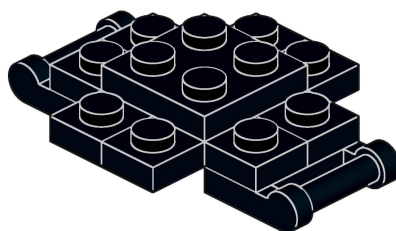

47

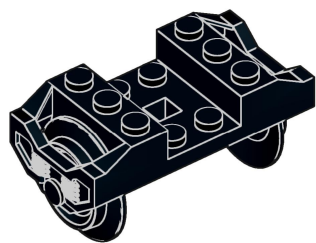

1x

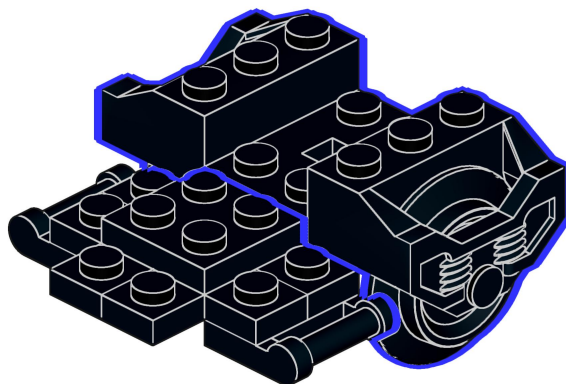

48

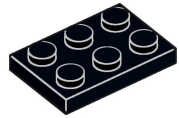

1x

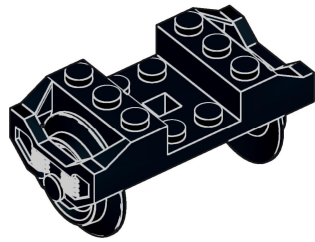

1x

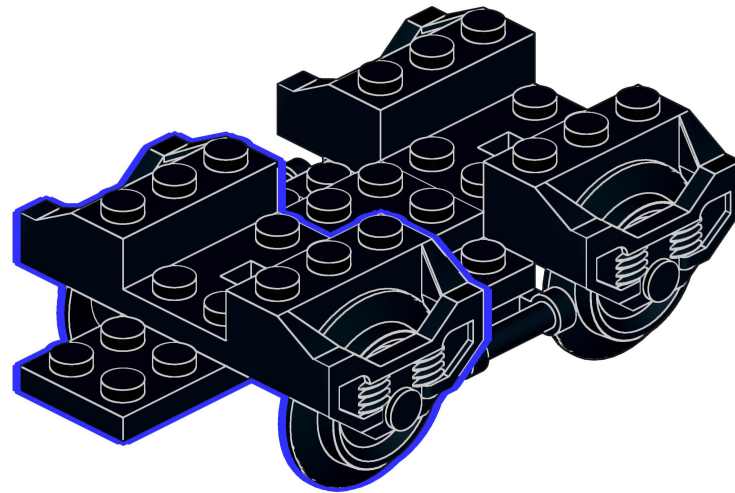

49

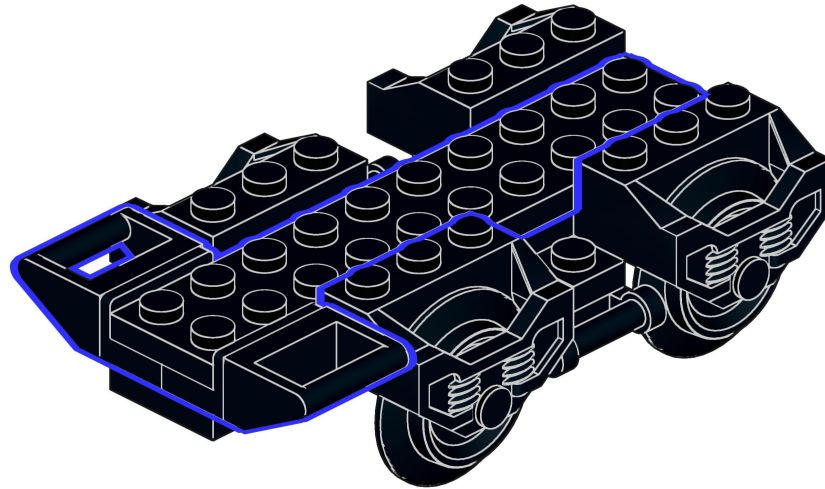
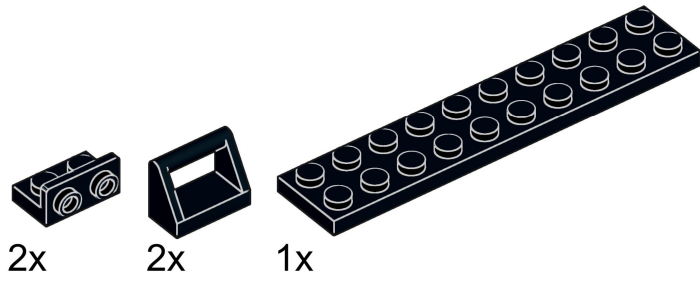

50



1x

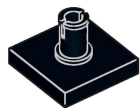

1x

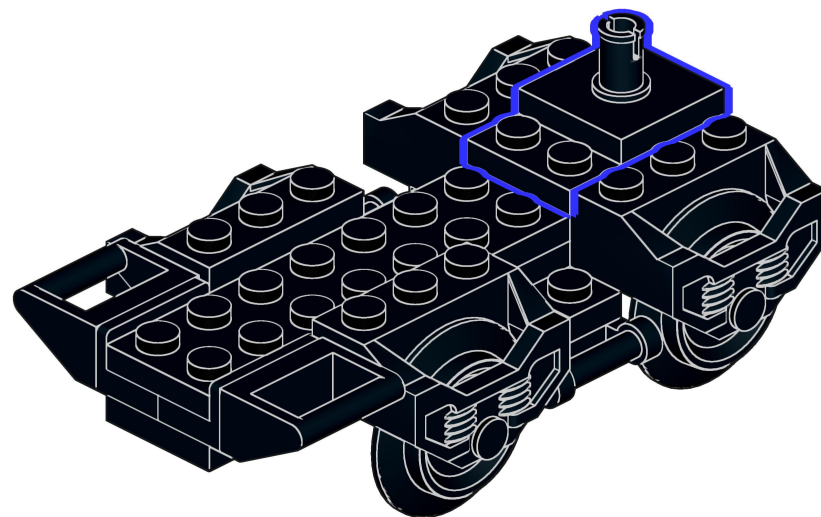

51

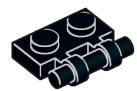

2x



2x

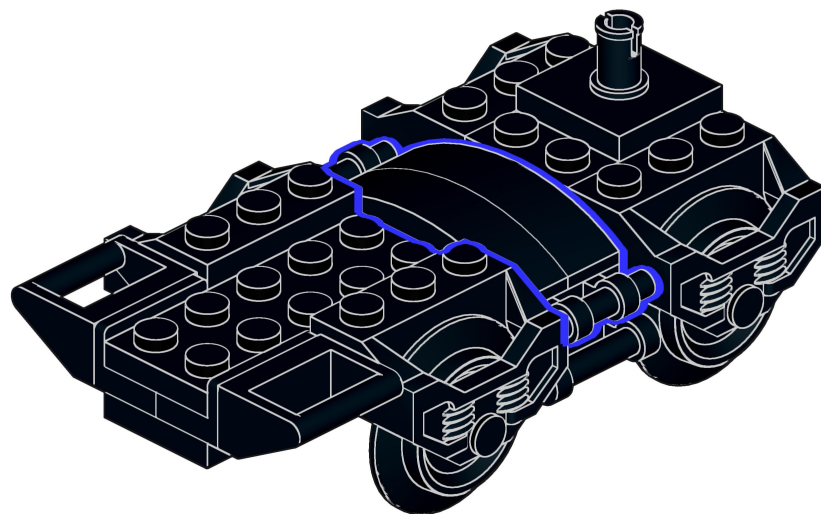

52

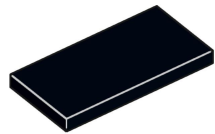

2x

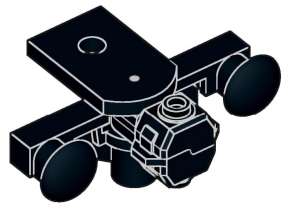

1x

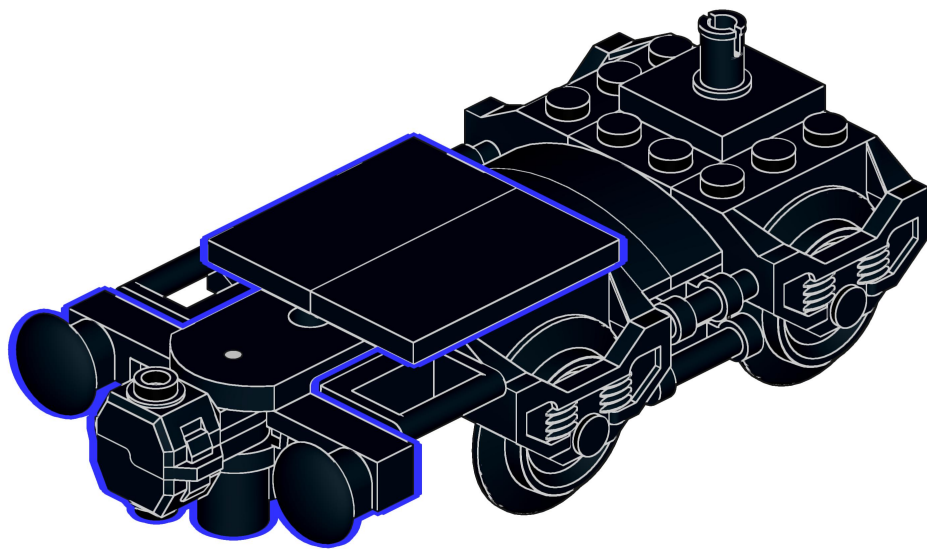

53

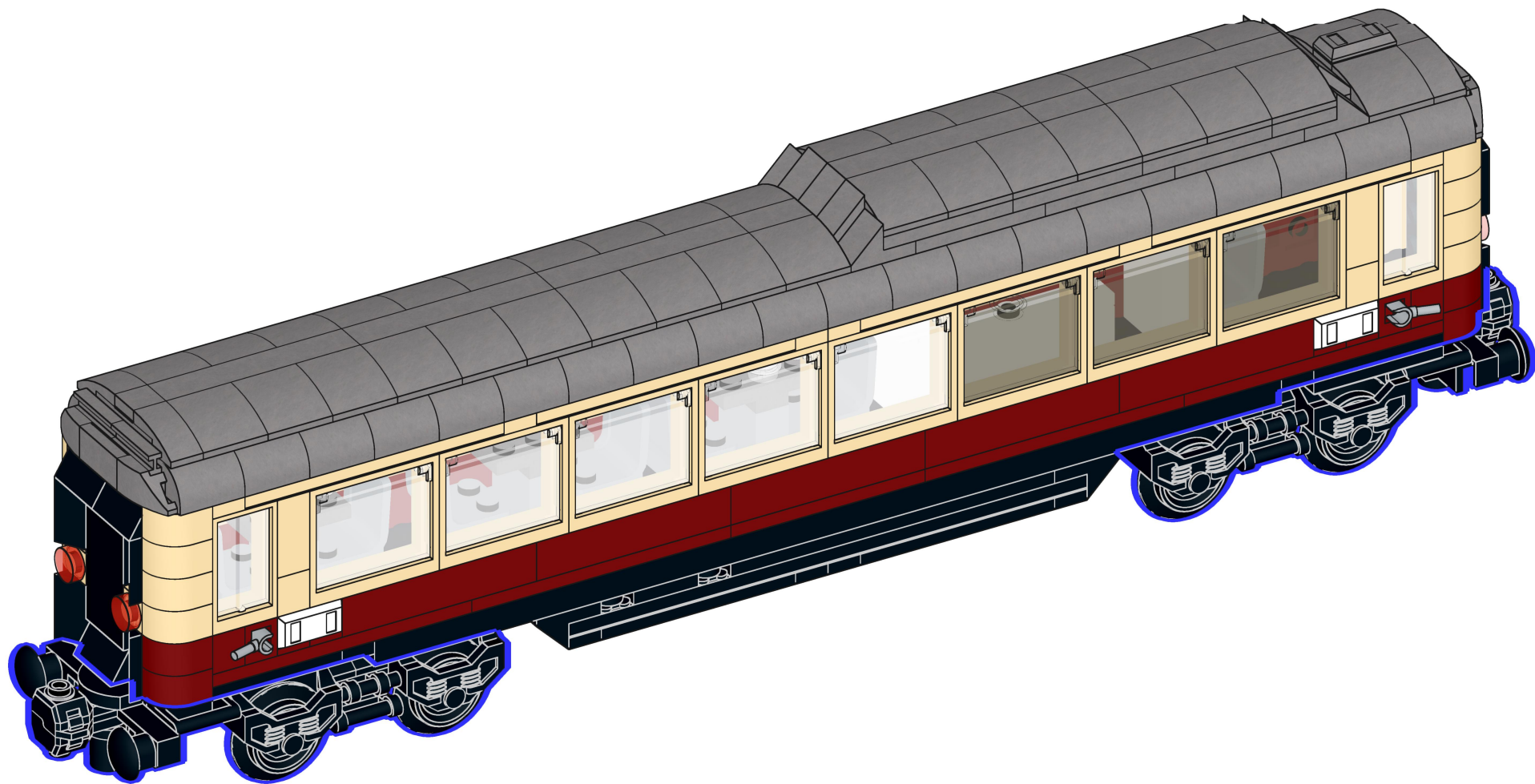

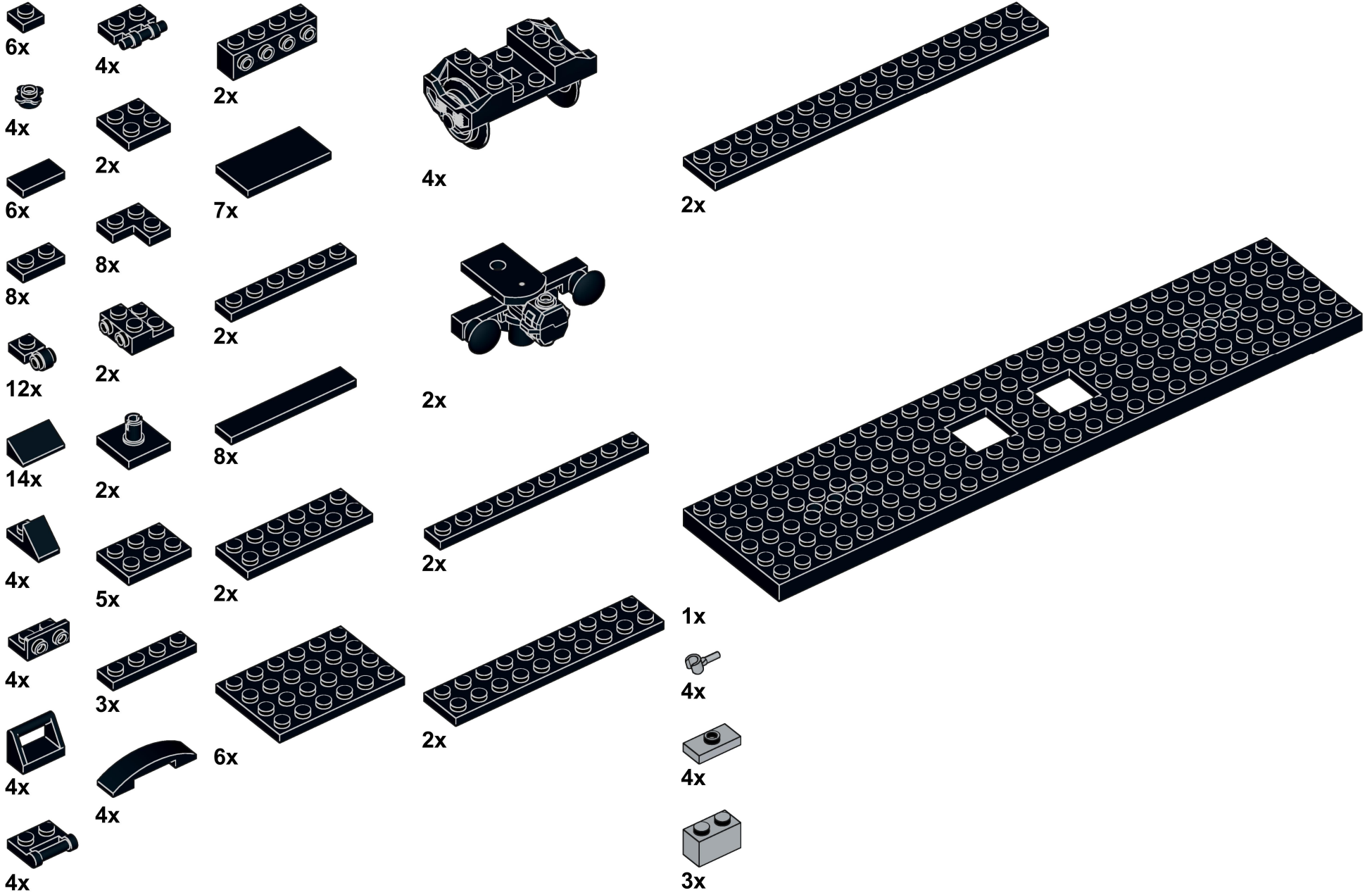

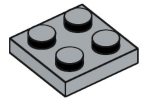

7x

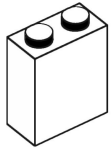

2x

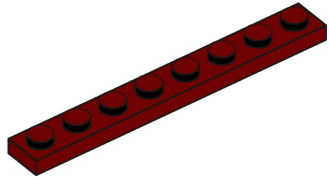

17x

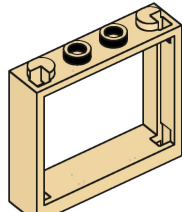

14x

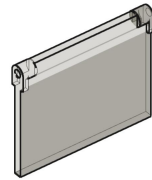

4x



2x



40x

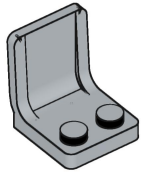

7x



12x



4x

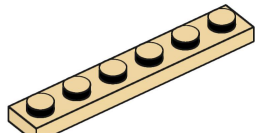

6x



5x

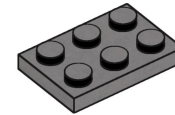

36x



3x



4x



4x



7x

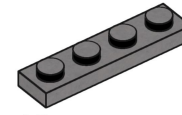

12x

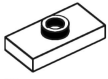

2x



8x



16x



1x

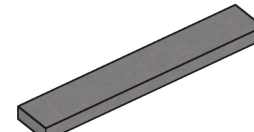

5x

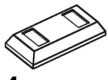

4x

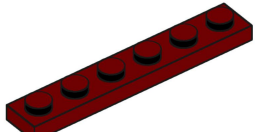

2x

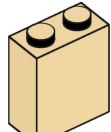

4x

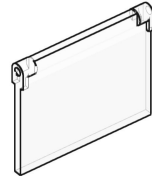

4x



8x



4x

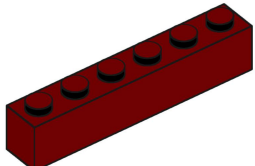

10x

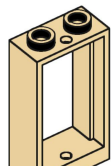

6x

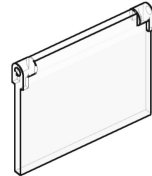

10x



4x

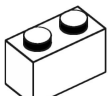

7x

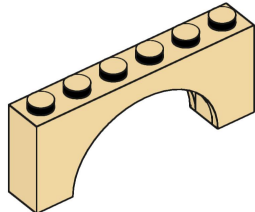
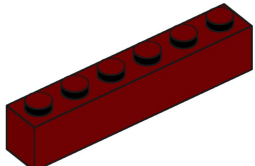

2x



4x



10x

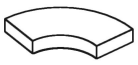

2x

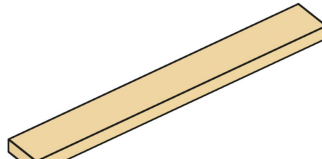

8x



2x



4x

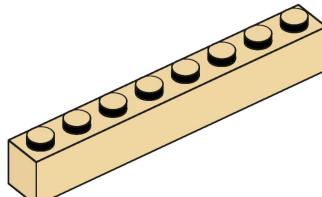

1x



2x

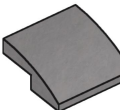

36x